



OLMITOS®

BABY PRODUCTS



www.olmitos.com

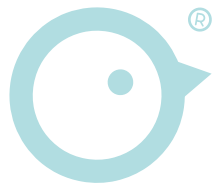

NUESTRA LABOR

En **Grupo Olmitos** llevamos más de 60 años dedicándonos al mundo infantil, primero como fabricantes de juguetes, y después creando productos seguros, innovadores y de alta calidad para los primeros años de vida de tu bebé. Como padres, conocemos vuestras necesidades y las de los más pequeños. Nos importa todo aquello que a vosotros os preocupa, por eso creamos productos muy prácticos y funcionales.

Nos esforzamos en mejorar día a día para acompañaros en la maravillosa tarea de la maternidad y la paternidad. Queremos estar presentes en todas vuestras aventuras y en los momentos más importantes de vuestros pequeños.

NUESTROS VALORES

Amamos lo que hacemos, y por encima de todo está el amor a las cosas bien hechas, y este es el valor que intentamos transmitir a través de nuestros productos.

La esencia de Grupo Olmitos es cuidar, no sólo a los más pequeños sino al resto de la familia, cuidar el entorno, de los trabajadores, de los clientes y cuidar de los nuestros.

**“Queremos estar presentes en todas
vuestras aventuras y en los momentos más
importantes de vuestros pequeños”**

ÍNDICE

INDEX

01 HOGAR / HOME

02 DORMIR / SLEEP

03 PRIMEROS PASOS / FIRST STEPS

04 SEGURIDAD / SAFETY

05 CONFORT / COMFORT

06 VIAJAR / TRAVEL

07 PASEO / WALK

08 BAÑO / BATH

09 COMER / EAT

SIMBOLOGÍA

SYMBOLOLOGY



LUZ / LIGHT



MÚSICA / MUSIC



MOVIMIENTO / MOVEMENT



SONIDO / SOUND



PILAS / BATERIES



VIBRACIÓN / VIBRATION



APTO MICROONDAS / MICROWAVEABLE



ECO FRIENDLY / ECO FRIENDLY



LIBRE DE BPA / BPA FREE

HOGAR
HOME



- ▶ Diseño moderno y minimalista
- ▶ Se puede utilizar desde el nacimiento en combinación con la hamaca para recién nacidos
- ▶ Hamaca con reductor
- ▶ Bandeja ajustable en 2 posiciones y extraíble
- ▶ Cojín acolchado de polipiel y extraíble para facilitar su limpieza
- ▶ Cinturón de seguridad de 3 puntos
- ▶ Reposapiés con 2 posiciones de altura
- ▶ Patas de madera de haya con antideslizantes
- ▶ Ganchos traseros para colgar la bandeja
- ▶ Tople de seguridad
- ▶ Plegable

- ▶ Modern and minimalist design
- ▶ Can be used from birth in combination with the newborn hammock
- ▶ Hammock with reducer
- ▶ Tray adjustable in 2 positions and removable
- ▶ Padded faux leather cushion, removable for easier cleaning
- ▶ 3-point seat belt
- ▶ 2-position foot rest in height
- ▶ Beech wooden legs with anti-slip
- ▶ Rear hooks to hang the tray
- ▶ Safety stop
- ▶ Foldable

01 HOGAR HOME

HAMACA | HAMMOCK



TRONA | HIGHCHAIR



01 HOGAR HOME

CARACTERÍSTICAS | FEATURES



*Hamaca con reductor
Hammock with reducer*



*Bandeja extraíble
Removable tray*



*Ganchos traseros para colgar la bandeja
Rear hooks to hang the tray*



*Reposapiés con 2 posiciones
2-position foot rest in height*



*Cinturón de seguridad de 3 puntos
3 Point seat belt*



*Plegable
Foldable*

+0m (Hamaca) / +6m (Trona) | Hasta 15 kg. (Trona)

67 x 54 x 88 cm. (trona abierta) - 40 x 54 x 85 cm. (trona cerrada) 71 x 43 x 18 cm. (hamaca) | 5'900 kg.

COLORES | COLORS



GIPRO GREY





- ▶ Trona de plástico muy resistente
- ▶ 5 en 1: trona, silla infantil, escritorio, mesa para ver películas y mesa de bloques de construcción
- ▶ Amplio asiento
- ▶ Respaldo reclinable
- ▶ Arnés de seguridad de 5 puntos
- ▶ Doble bandeja extraíble regulable en 3 posiciones
- ▶ Barra entrepierna para mayor seguridad
- ▶ Tapicería desenfundable
- ▶ Trona desde los 6 meses a los 3 años
- ▶ Mesa y silla de 2 a 6 años

- ▶ Very resistant plastic highchair
- ▶ 5 in 1: highchair, children's chair, desk, table to watch movies and table for building blocks
- ▶ Wide seat
- ▶ Reclining backrest
- ▶ 5-point safety harness
- ▶ Double adjustable removable tray in 3 positions
- ▶ Crotch bar for greater safety
- ▶ Removable upholstery
- ▶ High chair from 6 months to 3 years
- ▶ Table and chair from 2 to 6 years

01 HOGAR HOME

TRONA | HIGHCHAIR



SILLA + MESA | CHAIR + TABLE



01 HOGAR HOME

CARACTERÍSTICAS | FEATURES



Cinturón de seguridad de 5 puntos
5 Point seat belt



Doble bandeja extraíble
Double removable tray



Tope de seguridad
Safety stop



Silla y mesa infantil
Children's chair and table



Mesa de bloques de construcción
Building block table



Mesa para ver la tablet
Table to see the tablet

TRONA | +6m | Hasta 15 kg. | 59x100x55 cm. | 7'8 kg.

SILLA INFANTIL | +2 años | 50x44x58 cm. (silla infantil) - 58x55x48 cm. (mesa) | 7'8 kg.

COLORES | COLORS



HA033 FOREST



HA033 ANIMALS



- ▶ Práctica, moderna y funcional
- ▶ 5 funciones: trona, elevador, silla infantil, conjunto silla+mesa y taburete
- ▶ Desde los 6 meses a los 10 años. (trona 6 meses-3 años. Mesa+silla 7 meses-10 años)
- ▶ Estructura muy estable, patas más gruesas
- ▶ Fácil instalación sin herramientas
- ▶ Tapizado desenfundable acolchado
- ▶ Amplia bandeja extraíble
- ▶ Patas más gruesas
- ▶ Arnés de seguridad de 5 puntos
- ▶ Tope de seguridad en la entrepierna

- ▶ Practical, modern, and functional
- ▶ 5 functions: high chair, boost, child's chair, chair+table and stool set
- ▶ From 6 months to 10 years. (high chair 6 months-3 years. Table+chair 7 months-10 years)
- ▶ Very stable structure
- ▶ Easy installation without tools
- ▶ Removable padded upholstery
- ▶ Large removable tray
- ▶ Thicker legs
- ▶ 5 point safety harness
- ▶ Safety stop in the crotch

01 HOGAR HOME



CARACTERÍSTICAS | FEATURES



Bandeja extraíble
Removable tray



Arnés de 5 puntos
5 point harness



Tope de seguridad
Protective pads



Instalación sin herramientas
Tool free instalation



Tejido transpirable
Breathable fabric



Patas gruesas
Thicker legs

+6m (Trona max. 15 kg.) | +24m (Silla max. 20 kg.) | 59 x 55 x 100 cm. (trona) - 50 x 44 x 58 cm. (silla infantil) - 58 x 55 x 48 cm. (mesa) | 7'8 kg.

01 HOGAR HOME

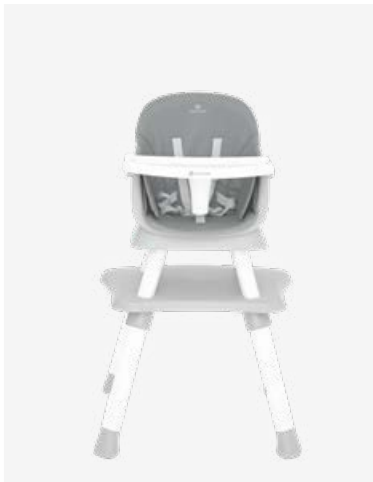

Trona
Highchair



Asiento elevador
Booster seat



Mesa y silla infantil
Children's table and chair



Taburete
Stool

COLORES | COLORS



HCY015-G GREY



HCY015-M MINT



- ▶ Trona práctica y ligera.
- ▶ 3 en 1: trona, silla infantil y conjunto de mesa con silla.
- ▶ Arnés de seguridad de 3 puntos.
- ▶ Bandeja extraíble.
- ▶ Barra entrepierna para mayor seguridad.
- ▶ Patas antideslizantes.
- ▶ Tapicería desenfundable.
- ▶ Trona desde los 6 meses a los 3 años.
- ▶ Mesa y silla de 3 a 6 años.

- ▶ Practical and light high chair.
- ▶ 3 in 1: high chair, children's chair and table and chair set.
- ▶ 3-point safety harness.
- ▶ Removable tray.
- ▶ Crotch bar for greater safety.
- ▶ Non-slip feet.
- ▶ Removable upholstery.
- ▶ High chair from 6 months to 3 years.
- ▶ Table and chair from 3 to 6 years.

01 HOGAR HOME

CARACTERÍSTICAS | FEATURES



Cinturón de seguridad de 3 puntos
3 point seat belt



Bandeja extraíble
Removable tray



Tope de seguridad
Safety stop



Instalación sin herramientas
Tool free instalation



Desfundable
Removable cover



Silla y mesa infantil
Children's chair and table

+6m | Hasta 15 kg. | 63 x 51 x 90 cm. (trona) - 41 x 39 x 50 cm. (silla infantil) - 63 x 51 x 46 cm. (mesa) | 4'3 kg.

COLORES | COLORS



TR2254903 JUNGLE



- ▶ Trona plegable compacta con asiento suave.
- ▶ Asiento de PVC para una fácil limpieza
- ▶ Arnés de 5 puntos
- ▶ Con posavasos en la bandeja

- ▶ Compact folding high chair with soft seat
- ▶ › Vinyl seat for easy cleaning
- ▶ › 5 point harness
- ▶ › With coasters in the included tray

01 HOGAR HOME

CARACTERÍSTICAS | FEATURES

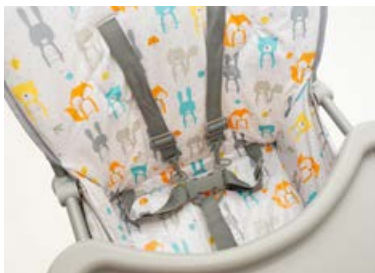

Arnés de 5 puntos
5 point harness



Reposapiés
Footrest

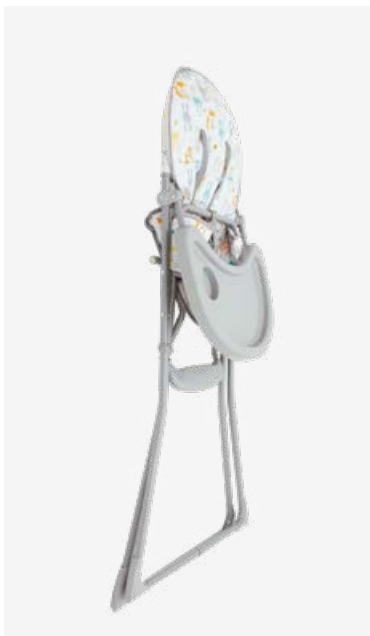

Plegable
Foldable



+6m | Hasta 15 kg. | 102 x 57 x 69 cm. / 120 x 57 x 20 cm. | 4'370 kg.

COLORES | COLORS



5203 ANIMALS



- ▶ Elegante hamaca de diseño
- ▶ El movimiento de balanceo impulsado por el propio movimiento y ritmo del bebé creará un efecto estimulante y relajante
- ▶ Diseñada para la transición del juego y el sueño
- ▶ Bolsillo de red trasero
- ▶ Fabricada de madera de haya 100% natural.
- ▶ Tejido de algodón

- ▶ Elegant design baby rocker
- ▶ The rocking movement driven by the baby's own movement and rhythm will create a stimulating and relaxing effect
- ▶ Designed to transition from play to sleep.
- ▶ Back mesh pocket
- ▶ Made of 100% natural beech wood.
- ▶ Cotton fabric

01 HOGAR HOME

CARACTERÍSTICAS | FEATURES



Arnés ajustable
Adjustable harness



Arnés acolchado
Padded harness

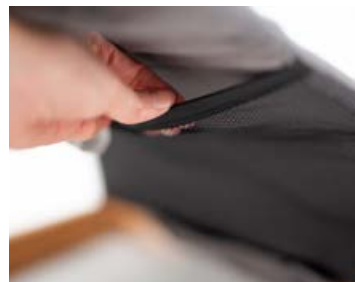

Bolsillo de red trasero
Back mesh pocket

+0m | Hasta 9 kg. aprox. | 68 x 53 x 45 cm. | 2,400 kg.

COLORES | COLORS



3021 ALMOND



3020 VAPOR



3023 MACADAMIA



3024 CAMELIA



- ▶ Función de balanceo natural, producido por el peso y los movimientos del bebé
- ▶ 2 posiciones de reclinado
- ▶ Función de música: 8 melodías a seleccionar
- ▶ Función de vibración
- ▶ Ajuste de volumen mediante pulsación larga
- ▶ Juguetero extraíble con peluches desmontables
- ▶ Fácil plegado y montaje
- ▶ Portátil, gracias a su plegado compacto es muy fácil de transportar
- ▶ Cinturón de seguridad de 3 puntos
- ▶ Vestidura suave y confortable

- ▶ Natural rocking function, produced by the weight and movements of the baby
- ▶ 2 recline positions
- ▶ Music function: 8 melodies to select
- ▶ Vibration function
- ▶ Volume adjustment by long press
- ▶ Removable toy box with removable stuffed animals
- ▶ Easy folding and assembly
- ▶ Portable, thanks to its compact folding it is very easy to transport
- ▶ 3-point seat belt
- ▶ Soft and comfortable clothing

01 HOGAR HOME

CARACTERÍSTICAS | FEATURES



Juguetero extraíble
Removable toy play



Cinturón de seguridad
Seat belt



2 Posiciones de reclinado
2 Reclining positions



Panel de control
Control panel

+0m | Hasta que el niño comience a tratar de incorporarse | 68 x 51 x 71 cm. - 86 x 51 x 10 cm. | 2,600 kg.



COLORES | COLORS



BY007G GREY



BY007B BEIG



- ▶ ETAPA 1 - HAMAQUITA. De 0 a 9 kgs.
 - ▶ ETAPA 2 - SILLA INFANTIL.
- Desde que el niño pueda sentarse o levantarse de un modo seguro por sí solo hasta los 18 kgs.
- ▶ Con mando selector de vibración
 - ▶ Modo fijo o balancín
 - ▶ Sistema de control con diferentes sonidos y melodías
 - ▶ Confección muy acolchada
 - ▶ Suave reposacabezas extraíble
 - ▶ Arnés de seguridad de 3 puntos con hebilla regulable y protector de entrepierna muy acolchado
 - ▶ Juguetero extraíble con peluches desmontables
 - ▶ Se desenfunda fácilmente para su limpieza.

- ▶ STAGE 1 - ROCKER. From 0 to 9 kg.
 - ▶ STAGE 2 - CHILD CHAIR.
- From when the child can sit or stand up safely on his own until 18kgs.
- ▶ Time select vibration
 - ▶ Fixed mode or rocker
 - ▶ Control system with different sounds and melodies
 - ▶ Very padded cover
 - ▶ Soft removable headrest
 - ▶ Safety harness 3-point adjustable buckle and very padded crotch guard
 - ▶ Removable toy bar with soft detachable toys
 - ▶ The cover pulls out easily for cleaning

01 HOGAR HOME

CARACTERÍSTICAS | FEATURES



ETAPA 1 - Hamaca
STAGE 1 - Hammock



ETAPA 2 - Silla infantil
STAGE 2 - Child chair



Modo fijo o balancín
Fixed mode or rocker



Panel de control
Control panel



Juguetero extraíble
Removable toy play bar



Reductor extraíble
Removable reducer

+0m | Hasta 9 kg. aprox. (hamaquita) - Hasta 18 kg. aprox. (silla infantil) | 79 x 63 x 48'5 cm. | 2'600 kg.



COLORES | COLORS



29289 GREY



29288 GREEN



29287 PINK



- ▶ 7 divertidas melodías para entretener al bebé
- ▶ 5 velocidades de balanceo
- ▶ 3 configuraciones de temporizador
- ▶ Barra de juguetes desmontable
- ▶ Se pliega fácilmente para transportar y guardar
- ▶ Asiento reclinable en 2 posiciones para una mayor comodidad del bebé
- ▶ Arnés de seguridad con sujeción para los hombros
- ▶ Reposacabezas extraíble

- ▶ 7 fun melodies entertain baby
- ▶ 5 swing speeds
- ▶ 3 timer settings
- ▶ Removable toy bar
- ▶ Easily folds for travel and storage
- ▶ Two position recline provides baby comfort
- ▶ Safety harness with shoulder restraint
- ▶ Removable headrest

01 HOGAR HOME

CARACTERÍSTICAS | FEATURES



Reclinable en dos posiciones
Two positions recline



5 velocidades de balanceo
5 swing speeds



7 melodías y 3 sonidos de naturaleza
7 Melodies and 3 natural sound



Barra de juguetes desmontable
Removable toy bar



Reposacabezas extraíble
Removable headrest



Se pliega fácilmente
Easily folds

+0m | Hasta 9 kg. aprox. | 71 x 57 x 57'5 cm. - 25 x 57 x 57'5 cm. | 3'800 kg.



COLORES | COLORS



6503 LION



6504 PINK



ABSORCIÓN DE
IMPACTOS
SHOCK ABSORPTION



RESISTENTE
AL AGUA
WATERPROOF



REVERSIBLE
REVERSIBLE



FÁCIL LIMPIEZA
EASY CLEANING

150x200
cm.



- ▶ Alfombra de espuma XPE plegable y ligera
- ▶ Ideal para gatear, jugar y aprender
- ▶ Textura antideslizante en ambas caras
- ▶ Reversible, un diseño diferente en cada lado
- ▶ Proporciona una buena amortiguación y absorbe los impactos
- ▶ Aislamiento térmico, resistente a la humedad e impermeable
- ▶ Se pliega fácilmente en pocos segundos para ahorrar espacio
- ▶ Práctica bolsa de transporte
- ▶ Fácil de limpiar
- ▶ Material no tóxico, libre de BPA, y de Ftalatos

- ▶ Lightweight, foldable XPE foam mat
- ▶ Ideal for crawling, playing and learning
- ▶ Non-slip texture on both sides
- ▶ Reversible, a different design on each side
- ▶ Provides good cushioning and absorbs shock
- ▶ Thermal insulation, moisture resistant and waterproof
- ▶ Easily folds in seconds to save space
- ▶ Practical transport bag
- ▶ Easy to clean
- ▶ Non-toxic material, free of BPA and Phthalates



Textura antideslizante
Non-slip texture



Plegable
Folding



Bolsa de viaje
Travel bag

+36m | 9 x 75 x 40 cm. - 150 x 200 cm. | 1'100 kg.

BPA FREE

FTALATOS FREE

NO TOXIC

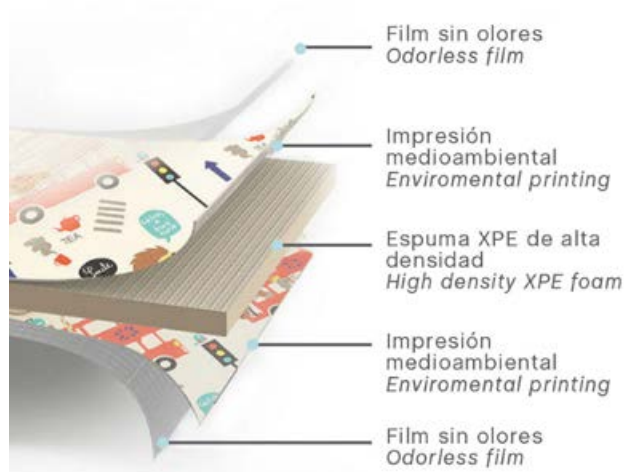



0900 TOWN-JUNGLE



0083 CIRCUS-FISH



Fabricado
en España



- ▶ Cambiador de espuma plastificado con tejido en PVC
- ▶ Acopla fácilmente en cualquier superficie
- ▶ Perfecto para conseguir un cómodo espacio de cambiador sobre una cómoda
- ▶ Laterales ligeramente elevados y redondeados.
- ▶ Con metro para medir al bebé
- ▶ Material de fácil limpieza
- ▶ Fabricado en España

- ▶ PVC-coated plasticized foam changer
- ▶ Easily attaches to any surface
- ▶ Perfect to get a comfortable changing room on a dresser
- ▶ Slightly raised and rounded sides
- ▶ With meter to measure the baby
- ▶ Easy to clean material
- ▶ Made in Spain

01 HOGAR HOME

CARACTERÍSTICAS | FEATURES



Con metro para medir al bebé
With meter to measure the baby



Laterales ligeramente elevados
Slightly raised sides

+0m | 50 x 80 x 9 cm. | 0'750 kg.

COLORES | COLORS



0080 LION



0081 SEAL

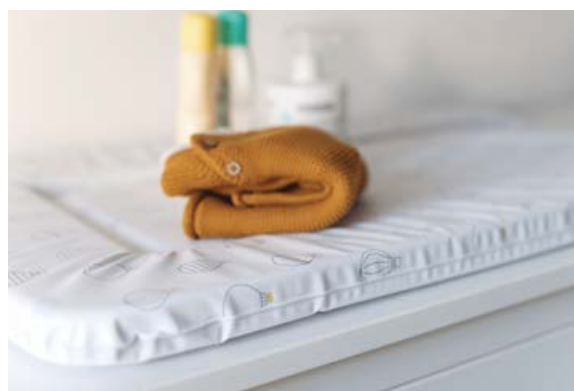

- ▶ Cambiador de espuma plastificado con tejido en PVC
- ▶ Acopla fácilmente en cualquier superficie
- ▶ Perfecto para conseguir un cómodo espacio de cambiador sobre una cómoda
- ▶ Laterales ligeramente elevados y redondeados.
- ▶ Con metro para medir al bebé
- ▶ Material de fácil limpieza

- ▶ PVC-coated plasticized foam changer
- ▶ Easily attaches to any surface
- ▶ Perfect to get a comfortable changing room on a dresser
- ▶ Slightly raised and rounded sides
- ▶ With meter to measure the baby
- ▶ Easy to clean material

01 HOGAR HOME

CARACTERÍSTICAS | FEATURES



*Laterales ligeramente elevados
Slightly raised sides*

+0m | 73 x 47 x 3'5 cm. | 0'383 kg.

COLORES | COLORS



8706 HOUSES



- ▶ Sistema "Odorless" patentado, evita la propagación del olor de los pañales, gérmenes y bacterias en cualquier espacio
- ▶ Sistema especial de sellado y "odor stop" práctico e inteligente invento diseñado para mantener los olores en su interior
- ▶ Se puede utilizar cualquier bolsa de plástico estándar
- ▶ Capacidad de almacenamiento de 25 pañales
- ▶ Fácil de usar con una sola mano para mantener a su bebé a salvo de accidentes repentinos durante el cambio del pañal
- ▶ Diseño elegante y moderno encaja bien en cualquier habitación para ajustarse perfectamente con el ambiente
- ▶ Incluye 15 bolsas

- ▶ Patented "Odorless" system, prevents the spread of the odor of diapers, germs and bacteria in any space
- ▶ Special sealing and "odor stop" system, practical and intelligent invention designed to keep odors inside
- ▶ Any standard plastic bag can be used
- ▶ Storage capacity of 25 diapers
- ▶ Easy to use with one hand to keep your baby safe from sudden accidents during diaper changes
- ▶ Sleek and modern design fits well in any room to fit perfectly with the environment
- ▶ Includes 15 bags

01 HOGAR HOME

CARACTERÍSTICAS | FEATURES



Fácil de usar con una sola mano
Easy to use with one hand



Protección contra los gérmenes y olores
Germ and odor protection



Capacidad de almacenamiento de 25 pañales
Storage capacity of 25 diapers



Se puede utilizar cualquier bolsa de plástico
Any standard plastic bag can be used



Incluye 15 bolsas
Includes 15 bags



Packaging
Packaging

+0m | 22'9 x 44'2 cm. | 1'62 kg.

COLORES | COLORS



1011055101 MAGIC

DORMIR
SLEEP



- ▶ Cuna de viaje plegable con opción de colecho
- ▶ Ligera, compacta y muy fácil de plegar y desplegar
- ▶ Lateral abatible y regulable en altura para adaptarse a diferentes alturas de camas
- ▶ Se fija a la cama para mayor seguridad y evitar que se mueva durante el uso
- ▶ Doble altura, para poder utilizarla desde el nacimiento
- ▶ Laterales de red para mayor visibilidad y para una mejor ventilación
- ▶ Incluye gatera para que el niño pueda entrar y salir durante el juego
- ▶ Ruedas con freno para su desplazamiento
- ▶ Con bolsa de transporte
- ▶ Puede utilizarse como parque de juegos

- ▶ Folding travel cot with co-sleeping option.
- ▶ Light, compact and very easy to fold and unfold
- ▶ Folding and height-adjustable side to adapt to different heights of beds
- ▶ It is fixed to the bed for added security and to prevent it from moving during use
- ▶ Double height, to be able to use it from birth
- ▶ Mesh sides for greater visibility and better ventilation
- ▶ Includes a cat flap so that the child can enter and exit during the game
- ▶ Wheels with brakes for movement
- ▶ With transport bag
- ▶ It can be used as a playground

02 DORMIR SLEEP

CARACTERÍSTICAS | FEATURES

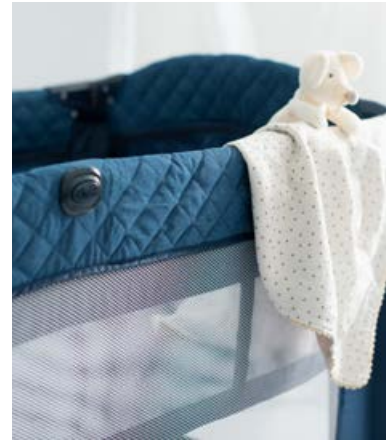

*Diseño de red en los 2 laterales
Network design on the 2 sides*



*Lateral regulable en 3 posiciones
3-position adjustable side*



*Colchoneta incluida
Mat included*



*Ruedas con freno de seguridad
Wheels with safety brake*

+0m | Hasta 15 kg. | 126 x 65 x 82 cm. - 80 24 x 26 cm. | 10'200 kg.

COLORES | COLORS



UP650S-G GREY



UP650S-M MARINE



- ▶ Ruedas para facilitar su ubicación con freno de seguridad
- ▶ Colchoneta incluida
- ▶ Su diseño de red, permite una buena ventilación y visibilidad
- ▶ Plegado compacto
- ▶ Bolsa de transporte incluida

- ▶ Wheels to assist location, with safety brake
- ▶ Network design, it allows a good ventilation and visibility
- ▶ Compact fold
- ▶ Mat included
- ▶ Carry bag included

02 DORMIR SLEEP

CARACTERÍSTICAS | FEATURES



Diseño de red en los 2 laterales
Network design on the 2 sides



Muy acolchada
Very padded



Colchoneta incluida
Mat included



Ruedas con freno de seguridad
Wheels with safety brake

+0m | Hasta 15 kg. | 66 x 79 x 126 cm. / 22 x 23 x 126 cm. | 8'600 kg.

COLORES | COLORS



0130 LITTLE STARS GREY



0131 LITTLE STARS BLUE



- ▶ Estructura muy estable y confortable colchón-base
- ▶ Muy ligera gracias a su patas de aluminio
- ▶ Práctico elevador incluido
- ▶ Su diseño de red, permite una buena ventilación y visibilidad
- ▶ Plegado muy compacto
- ▶ Con bolsa de transporte

- ▶ Very light thanks to its aluminium legs
- ▶ Practical lifting mattress included
- ▶ Network design, it allows a good ventilation and visibility
- ▶ Folding compact
- ▶ With carry bag

02 DORMIR SLEEP

CARACTERÍSTICAS | FEATURES



*Puerta lateral
Side door*



*Elevador desmontable
Removable lifting mattress*



*Bolsa de transporte
Carry bag*



1



2



3

+0m | Hasta 13 kg. o 85 cm. | 71 x 110 x 65 cm. - 18 x 68 x 51 cm. | 5'800 kg.

COLORES | COLORS



1694 ERIZO



- ▶ Colchón para cuna, muy práctico y cómodo, fabricado con tejido de rizo para una mejor transpiración
- ▶ Se desenfunda fácilmente para su limpieza

- ▶ Mattress for crib, very practical and comfortable, made of terry cloth for better breathability
- ▶ Easily disintegrates for cleaning

02 DORMIR SLEEP

CARACTERÍSTICAS | FEATURES



Desenfundable
Practical front opening



Tejido de rizo
Terry cloth



Plegable
Foldable

+0m | 60 x 7'5 x 120 cm. - 60 x 27 x 30 cm. | 0'645 kg.

COLORES | COLORS



2636 WHITE

02 DORMIR SLEEP

COLCHÓN AUTOHINCHABLE SELF-INFLATABLE MATTRESS

COLORES | COLORS



2634 BLACK



2635 GREY

- ▶ Adaptable a la mayoría de cunas estándar
 - ▶ Plegado compacto
 - ▶ Válvula autohinchable, sin soplar, se hincha simplemente abriendo la válvula, y se desincha fácilmente
 - ▶ Incluye bolsa de viaje
- ▶ Fits most of standard cots
 - ▶ Compact folding
 - ▶ Self-inflating valve, without blowing, swells simply, opening the valve, and easily deflates
 - ▶ Travel bag including

CARACTERÍSTICAS | FEATURES

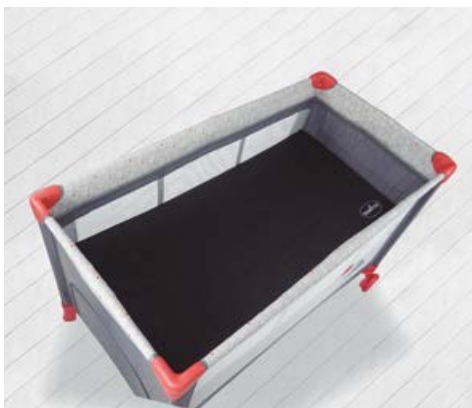

Apto para la mayoría de cunas
Suitable for most cribs

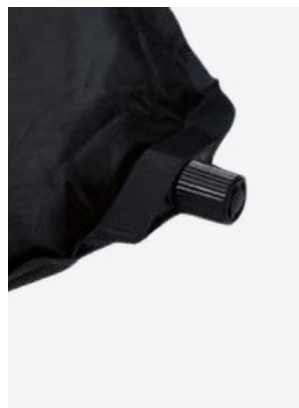

Válvula autohinchable
Self-inflating valve



Bolsa de viaje
Travel bag

+0m | 120 x 60 x 4'3 cm - 20 x 20 x 33 cm. | 1 kg.



- ▶ Para ayudar al niño a levantarse dentro del parque
- ▶ 4 unidades

- ▶ They help the child to stand up inside the playpen
- ▶ 4 units

CARACTERÍSTICAS | FEATURES

+0m | 9 x 11 x 2'5 cm. | 0'280 kg.

COLORES | COLORS





COLORES | COLORS



3626 FOREST

- ▶ Suaves peluches que giran acompañados de una dulce melodía que entretendrá al bebé estimulando sus sentidos
- ▶ Funciona con cuerda que se acciona mediante llave

- ▶ The characters dance to a gentle lullaby with merry-go-round motion attracts baby's attention
- ▶ Works with a spring wound with a key

CARACTERÍSTICAS | FEATURES

+0m | 40 x 57 x 42 cm. | 0'427 kg.



1^{OS} PASOS
FIRST STEPS



- ▶ 3 en 1: andador, modo correpasillos y modo carrito de empuje. El bebé aprenderá a dar sus primeros pasos de forma cómoda y segura
- ▶ Bandeja didáctica con música, luces y juegos
- ▶ Asiento acolchado
- ▶ Sistema STOPPER que bloquea el desplazamiento ante un escalón
- ▶ Ruedas delanteras giratorias de goma y ruedas traseras solo hacia adelante. Las ruedas traseras tienen velocidad ajustable que se puede modificar según la fuerza del niño.
- ▶ Bloqueo de seguridad para prevenir el plegado accidental
- ▶ Plegado muy fácil

- ▶ 3 in 1: walker, ride-on mode and pushchair mode. This baby walker the baby will learn to take his first steps comfortably and safely
- ▶ Didactic tray with music, lights and games
- ▶ Padded seat
- ▶ STOPPER system that blocks the movement before a step
- ▶ Rubber swivel front wheels and forward only rear wheels. The rear wheels have adjustable speed that can be modified according to the child's strength
- ▶ With safety lock to prevent accidental folding
- ▶ Folding very easy

03 1^{OS} PASOS FIRST STEPS

CARACTERÍSTICAS | FEATURES



Bandeja de actividades
Activity tray



Ruedas de goma multidireccionales
Multidirectional rubber wheels



Asiento extraíble
Removable seat



Andador
Walker



Correpasillos
Ride-on



Carrito de empuje
Push trolley

+6m | Hasta 12 kg. | 73 x 64 x 50,5 cm. - 73 x 64 x 29 cm. | 4,06 kg.



COLORES | COLORS



2137 C



- ▶ El bebé aprenderá a dar sus primeros pasos de forma cómoda y segura
- ▶ Bandeja didáctica con música y juegos
- ▶ Asiento acolchado y altura regulable de 3 puntos
- ▶ Sistema STOPPER que bloquea el desplazamiento ante un escalón
- ▶ Sus 4 ruedas de goma para proteger la superficies mas delicadas le confieren una total estabilidad
- ▶ Bloqueo de seguridad para prevenir el plegado accidental
- ▶ Plegado muy fácil

- ▶ This baby walker the baby will learn to take his first steps comfortably and safely
- ▶ Didactic tray with music, lights and games
- ▶ Padded seat and height adjustable 3 points
- ▶ STOPPER system that blocks the movement before a step
- ▶ Its 4 wheels to protect the most delicate surfaces give it total stability
- ▶ With safety lock to prevent accidental folding
- ▶ Folding very easy

03 1^{OS} PASOS FIRST STEPS

CARACTERÍSTICAS | FEATURES



Plegable
Foldable



Bandeja con música y juegos
Tray with music and games



Ruedas de goma
Rubber wheels

+6m | Hasta 12 kg. | 70 x 64 x 65 cm. - 70 x 64 x 11 cm. | 3,400 kg.



COLORES | COLORS



8036 P



8036 B



- ▶ El bebé aprenderá a dar sus primeros pasos de forma cómoda y segura
- ▶ Bandeja didáctica con música, luces y juegos
- ▶ Asiento acolchado y altura regulable de 3 puntos
- ▶ Sistema STOPPER que bloquea el desplazamiento ante un escalón
- ▶ Sus 4 ruedas de goma para proteger la superficies mas delicadas le confieren una total estabilidad
- ▶ Bloqueo de seguridad para prevenir el plegado accidental
- ▶ Plegado muy fácil

- ▶ This baby walker the baby will learn to take his first steps comfortably and safely
- ▶ Didactic tray with music, lights and games
- ▶ Padded seat and height adjustable 3 points
- ▶ STOPPER system that blocks the movement before a step
- ▶ Its 4 wheels to protect the most delicate surfaces give it total stability
- ▶ With safety lock to prevent accidental folding
- ▶ Folding very easy

03 1^{OS} PASOS FIRST STEPS

CARACTERÍSTICAS | FEATURES

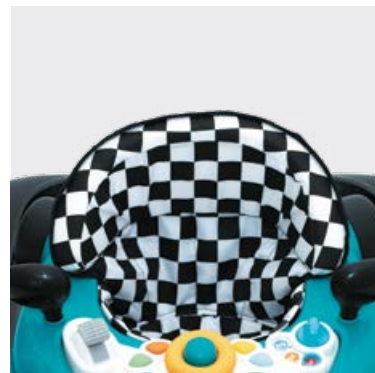

Asiento extraíble
Removable seat



Bandeja de actividades
Activity tray



Ruedas de goma
Rubber wheels



Plegable
Foldable

+6m | Hasta 12 kg. | 70 x 64 x 54 cm. - 15 x 65 x 72 cm. | 4 kg.



COLORES | COLORS



2080 RED



2081 BLUE



- ▶ El bebé aprenderá a dar sus primeros pasos de forma cómoda y segura
- ▶ Bandeja didáctica con música, luces y juegos
- ▶ Asiento acolchado y altura regulable de 3 puntos
- ▶ Sistema STOPPER que bloquea el desplazamiento ante un escalón
- ▶ Sus 4 ruedas de goma para proteger la superficies mas delicadas le confieren una total estabilidad
- ▶ Bloqueo de seguridad para prevenir el plegado accidental
- ▶ Plegado muy fácil

- ▶ This baby walker the baby will learn to take his first steps comfortably and safely
- ▶ Didactic tray with music, lights and games
- ▶ Padded seat and height adjustable 3 points
- ▶ STOPPER system that blocks the movement before a step
- ▶ Its 4 wheels to protect the most delicate surfaces give it total stability
- ▶ With safety lock to prevent accidental folding
- ▶ Folding very easy

03 1^{OS} PASOS FIRST STEPS

CARACTERÍSTICAS | FEATURES



Bandeja de actividades
Activity tray



Asiento extraíble
Removable seat



Ruedas de goma
Rubber wheels

+6m | Hasta 12 kg. | 70 x 64 x 51 cm. - 70 x 64 x 11 cm. | 3'700 kg.



COLORES | COLORS



2076 GREEN STARS



- ▶ El bebé aprenderá a dar sus primeros pasos de forma cómoda y segura.
- ▶ Bandeja didáctica: música, sonido y juegos.
- ▶ Asiento extraíble, acolchado y cómodo.
- ▶ Regulable a la altura del niño.
- ▶ Base anatómica que proporciona gran estabilidad.
- ▶ Puede usarse con las ruedas para aprender a caminar o en modo balancín.
- ▶ Como balancín está equipado con un reposapiés para asegurar la correcta postura del bebé mientras se balancea.
- ▶ Ruedas de goma para proteger las superficies más delicadas.
- ▶ Sistema STOPPER que bloquea el desplazamiento ante un escalón.
- ▶ Bloqueo de seguridad para prevenir el bloqueo accidental.
- ▶ Se pliega fácilmente.

- ▶ Teaching tray with music, sound, and games.
- ▶ Removable, padded, and comfortable seat.
- ▶ Adjustable to the child's height.
- ▶ Anatomical base provides stability.
- ▶ The wheels can be used to learn to walk or rocking mode.
- ▶ As rocker is equipped with a footrest to ensure the correct position while baby swings.
- ▶ Rubber wheel to protect the most delicate surfaces.
- ▶ STOPPER safety system to lock the walker when it comes to a staircase.
- ▶ Safety lock to prevent accidental locking.
- ▶ Easy to fold.

03 1^{OS} PASOS FIRST STEPS

CARACTERÍSTICAS | FEATURES



Modo balancín
Rocker mode



Confección extraíble para su limpieza
Removable confection for cleaning



Bandeja con música, luces y juegos
Tray with music, lights and games



Ruedas de goma
Rubber wheels



Plegable
Foldable

+6m | Hasta 12 kg. | 72 x 66 x 50 cm. - 72 x 66 x 11 cm. | 3'700 kg.



COLORES | COLORS



2073 ANIMALS



- ▶ Divertido y educativo, con el que el bebé aprenderá a coordinar sus movimientos y a estimular sus sentidos mientras se entretiene con sus juegos, luces y sonidos
- ▶ Base muy sólida y asiento muy cómodo.
- ▶ Altura regulable en 3 posiciones para adaptarse al tamaño del bebé.
- ▶ Su base puede utilizarse de forma fija o en modo "Jump" para que el bebé pueda dar saltitos.

- ▶ Fun and educational, to help your child learn to coordinate movements and stimulate the senses with games, lights, and sounds.
- ▶ Solid base with a comfy seat.
- ▶ 3-position height adjustment.
- ▶ Can be used in fixed or 'jump' (baby hopping) mode.
- ▶ Folding very easy.

03 1^{OS} PASOS FIRST STEPS

CARACTERÍSTICAS | FEATURES



Asiento giratorio
Swivel seat



Bandeja didáctica
Teaching panel



Diversas posiciones de la base
Different positions of the base



Mesa de juego
Play table

+6m | Hasta 11 kg. | 65 x 52 x 65 cm. | 3'600 kg.



COLORES | COLORS



1476 ZIGZAG GREEN



1477 ZIGZAG ORANGE

SEGURIDAD
SAFETY



- ▶ Cuando el niño pasa de la cuna a la cama, evita que caiga mientras duerme
- ▶ Fácil de instalar debajo del colchón
- ▶ Abatible, no hace falta extraerla para hacer la cama
- ▶ Sistema de anclaje, la barrera se abre fácilmente para acceder a todo tipo de camaS (incluidas la mayoría de camas nido)
- ▶ Nuevo sistema de sujeción con tope ajustable, la barrera quedará bien sujeta evitando que se desplace
- ▶ Su red permite la total visibilidad del niño
- ▶ Su sistema de plegado resulta ideal para viajar
- ▶ Ancho del colchón min. 90 y max. 105 cm.

- ▶ When the baby moves from cot to bed to prevent baby from falling during sleep
- ▶ Easy to insert under the mattress
- ▶ Folding, it is not necessary to remove it to make the bed
- ▶ Fastening system, the bed rail is easily opened to access all bedding (including the most trundle bed)
- ▶ New fastening system with adjustable stop allowing the bed rail fits securely preventing shifting
- ▶ The net gives total visibility of the child
- ▶ Its folding system ideal for traveling
- ▶ Mattress width min. 90 and max. 105 cm.

04 SEGURIDAD SAFETY

CARACTERÍSTICAS | FEATURES



Nuevo sistema de sujeción
New fixing system



Malla de red para una mayor visibilidad
Mesh network for greater visibility



Abatible
Folding



Bolsa de transporte
Carry bag

+18m | 59'50 x 151 cm. - 80 x 10 x 22 cm. | 3 kg.

COLORES | COLORS

7664 BLUE BEAR



7665 GREY SLOTH





- ▶ Cuando el niño pasa de la cuna a la cama, evita que caiga mientras duerme
- ▶ Fácil de instalar debajo del colchón
- ▶ Abatible, no hace falta extraerla para hacer la cama
- ▶ Sistema de anclaje, la barrera se abre fácilmente para acceder a todo tipo de camaS (incluidas la mayoría de camas nido)
- ▶ Nuevo sistema de sujeción con tope ajustable, la barrera quedará bien sujeta evitando que se desplace
- ▶ Su red permite la total visibilidad del niño
- ▶ Su sistema de plegado resulta ideal para viajar
- ▶ Ancho del colchón min. 90 y max. 105 cm.

- ▶ When the baby moves from cot to bed to prevent baby from falling during sleep
- ▶ Easy to insert under the mattress
- ▶ Folding, it is not necessary to remove it to make the bed
- ▶ Fastening system, the bed rail is easily opened to access all bedding (including the most trundle bed)
- ▶ New fastening system with adjustable stop allowing the bed rail fits securely preventing shifting
- ▶ The net gives total visibility of the child
- ▶ Its folding system ideal for traveling
- ▶ Mattress width min. 90 and max. 105 cm.

04 SEGURIDAD SAFETY

CARACTERÍSTICAS | FEATURES



*Nuevo sistema de sujeción
New fixing system*



*Malla de red para una mayor visibilidad
Mesh network for greater visibility*



*Abatible
Folding*



*Bolsa de transporte
Carry bag*

+18m | 59'50 x 151 cm. - 80 x 10 x 22 cm. | 3 kg.

COLORES | COLORS



7661 LITTLE STAR



7662 GREY STARS

04 SEGURIDAD SAFETY



7648 WHITE



7649 MARINE

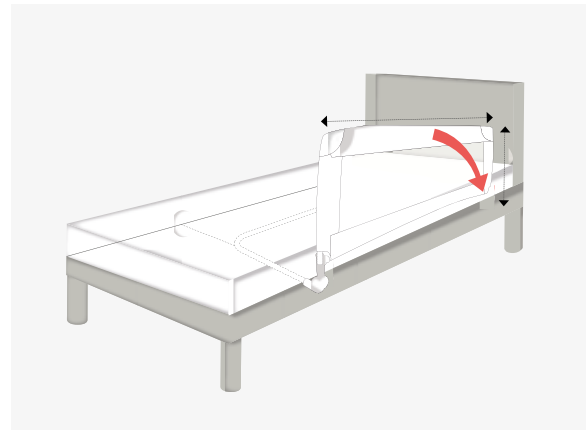

- ▶ Cuando el niño pasa de la cuna a la cama, evita que caiga mientras duerme
- ▶ Fácil de instalar debajo del colchón
- ▶ No hace falta extraerla para hacer la cama gracias a su movimiento abatible
- ▶ Gracias a su sistema de anclaje, la barrera se abre fácilmente para acceder a todo tipo de cama (incluidas la mayoría de camas nido)
- ▶ Nuevo sistema de sujeción con tope ajustable que permite que la barrera quede bien sujeta evitando que se desplace
- ▶ Su red permite la total visibilidad del niño
- ▶ Su sistema de plegado resulta ideal para viajar
- ▶ Ancho del colchón min. 90 y max. 105 cm.

- ▶ When the baby moves from cot to bed to prevent baby from falling during sleep
- ▶ Easy to insert under the mattress
- ▶ When making the bed, no need to remove them as they can be folded down
- ▶ Thanks to its fastening system, the bed rail is easily opened to access all bedding (including the most trundle bed)
- ▶ New fastening system with adjustable stop allowing the bed rail fits securely preventing shifting
- ▶ The net gives total visibility of the child
- ▶ Its folding system ideal for traveling
- ▶ Mattress width min. 90 and max. 105 cm.



7650 BABIES



- ▶ Ideal para viajar (con bolsa de transporte) y de fácil instalación
- ▶ Evita que el niño caiga mientras duerme
- ▶ No hace falta extraerla para hacer la cama gracias a su movimiento abatible
- ▶ Nuevo sistema de sujeción de placas metálicas permite que la barrera quede bien sujeta evitando que se desplace
- ▶ Su red permite la total visibilidad del niño

- ▶ Perfect for travelling (with travel bag) and easy installation
- ▶ When the baby moves from cot to bed to prevent baby from falling during sleep
- ▶ When making the bed, no need to remove them as they can be folded down
- ▶ New fixing system allows the rail to be fastened securely so that it does not move
- ▶ The net gives total visibility of the child

+18m | 50 x 39 x 130 cm. - 65 x 18'5 x 7'50 cm. | 2'200 kg.

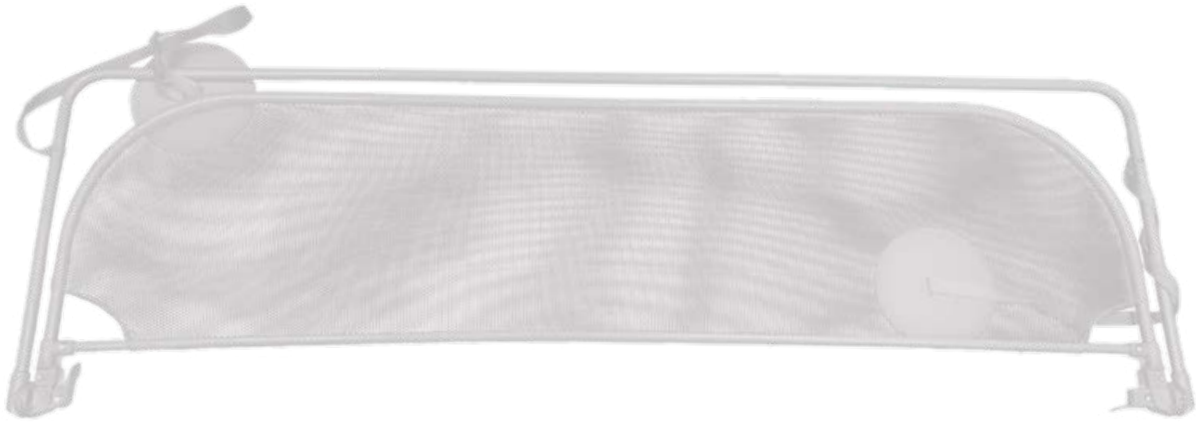

7606 WHITE

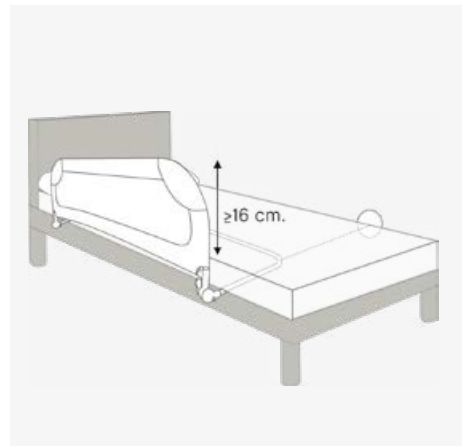

- ▶ Muy práctica para que el niño esté seguro en la cama y evitar caídas
- ▶ Su red permite total visibilidad del niño
- ▶ Nuevo sistema de sujeción con tope ajustable que permite que la barrera quede bien sujeta evitando que se desplace
- ▶ Muy cómoda para hacer la cama, no hace falta extraerla gracias a su movimiento abatible
- ▶ Sistema de cierre más seguro
- ▶ Ancho del colchón min. 90 y max. 105 cm.

- ▶ Very practical to make sure that the child is safe in the bed and will not fall out
- ▶ The net gives total visibility of the child
- ▶ New fastening system with adjustable stop allowing the bed rail fits securely preventing shifting
- ▶ Very convenient when making the bed, no need to remove them as they can be folded down
- ▶ System of closing more secure
- ▶ Mattress width min. 90 and max. 105 cm.



7644 PANDA BEAR



7643 SWEET RABBIT

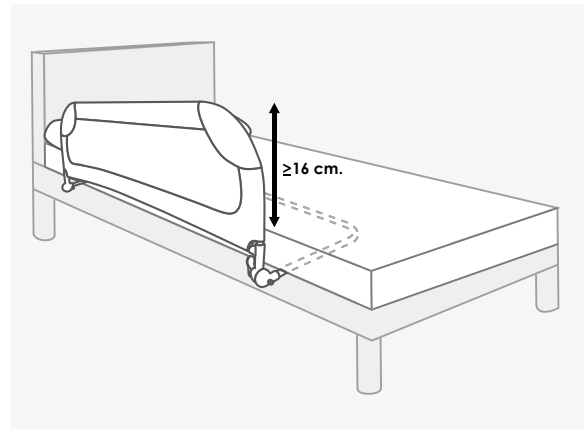

- ▶ Muy práctica para que el niño esté seguro en la cama y evitar caídas
- ▶ Su red permite total visibilidad del niño
- ▶ Muy cómoda para hacer la cama, no hace falta extraerla gracias a su movimiento abatible
- ▶ Sistema de cierre más seguro

- ▶ Very practical to make sure that the child is safe in the bed and will not fall out
- ▶ The net gives total visibility of the child
- ▶ Very convenient when making the bed, no need to remove them as they can be folded down
- ▶ System of closing more secure



- ▶ Fácil de instalar
- ▶ Doble cierre de seguridad
- ▶ Sistema de cierre automático
- ▶ Se abre en 2 direcciones
- ▶ Adaptable a puertas o huecos de entre 75 y 80 cm
- ▶ Puede instalarse en puertas o huecos más grandes acoplándole las extensiones de Olmitos de 10cm. (Ref. 9035) o 20cm. Ref. 9036), (no incluidas).

- ▶ Easy to install
- ▶ Double safety lock
- ▶ Automatic closing system
- ▶ Opens in 2 directions
- ▶ Adaptable to doors or openings between 75 and 80 cm
- ▶ It can be installed in larger doors or openings by attaching the 10cm Olmitos extensions. Ref. 9035) or 20cm. Ref. 9036), (not included).

04 SEGURIDAD SAFETY

CARACTERÍSTICAS | FEATURES



*Doble cierre de seguridad
Double safety lock*

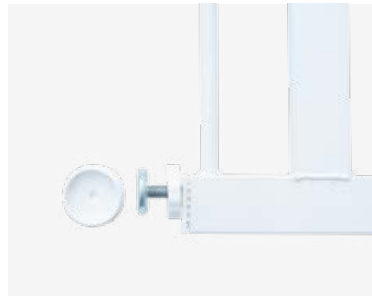

*Tornillo de ajuste con copa de sujeción
Adjustment screw with clamping cup*



*Cerradura de seguridad
Safety lock*

+6m | 76 x 75-80 cm. | 4'800 kg.

COLORES | COLORS

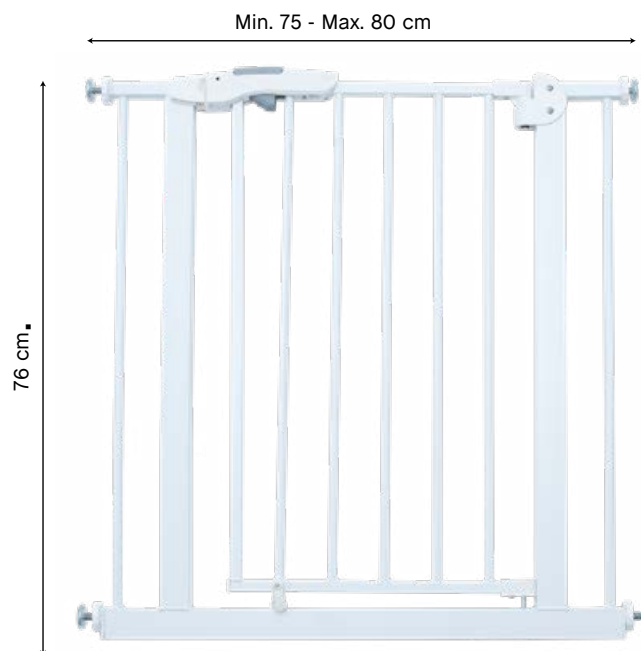

9034 WHITE



XY008A WHITE

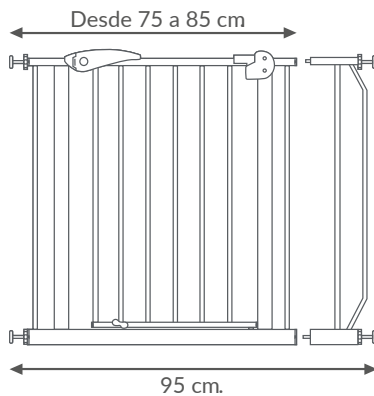

- ▶ Sistema de bloqueo de seguridad
- ▶ Adaptable a puertas o huecos de entre 75 y 85 cm
- ▶ Puede instalarse en puertas o huecos de hasta 95 cm. acoplándole la extensión de 10cm. incluida
- ▶ Abertura a ambos lados
- ▶ No necesita perforar las paredes para su instalación

- ▶ Safety gate with safety locking system
- ▶ Adaptable to openings between 75 and 85 cm.
- ▶ Can be installed in openings up to 95 cm, using the 10 cm. extension included
- ▶ Open in both sides
- ▶ No need to drill the wall to install

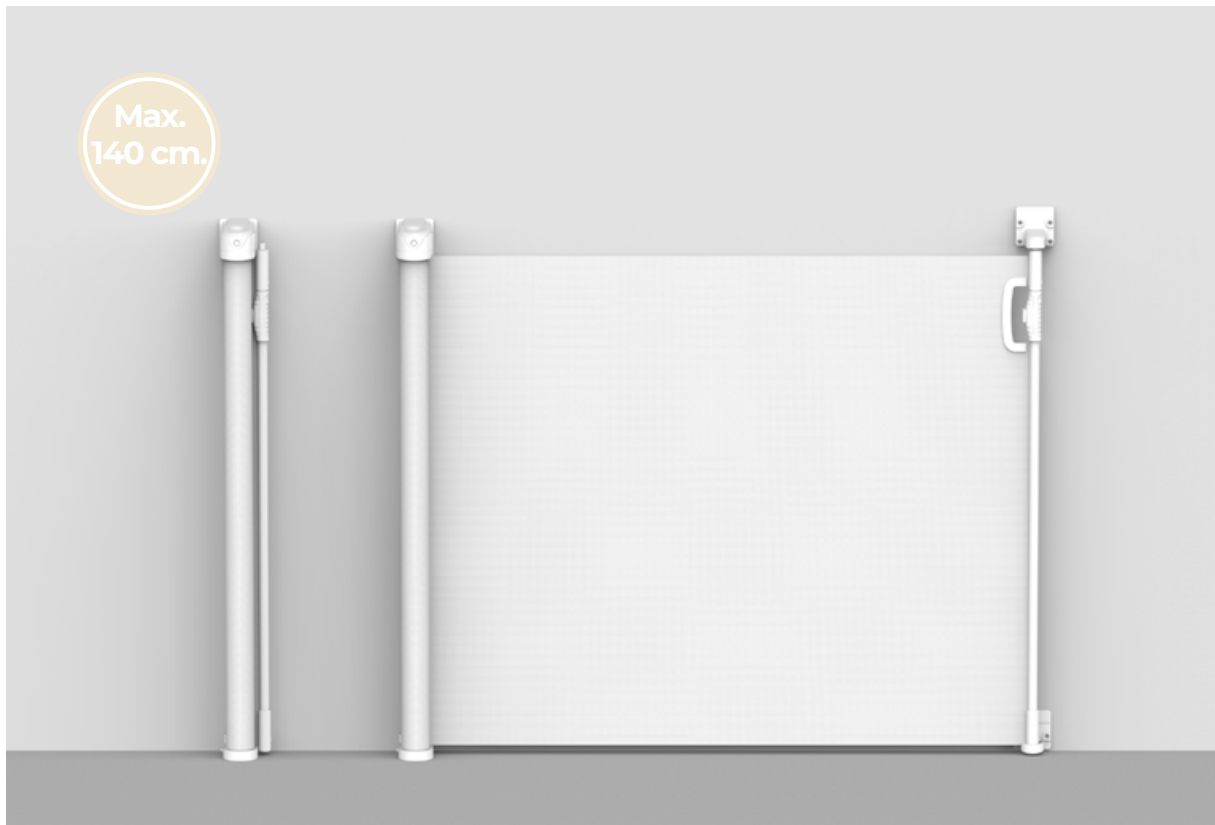

- ▶ Hasta 140 cm. ancho
- ▶ Para escaleras, puertas, interior y exterior.
- ▶ Mecanismo de bloqueo automático
- ▶ Fácil de usar mientras sostienes al bebé
- ▶ Operación con una sola mano.
- ▶ Diseño retráctil
- ▶ Puerta de malla resistente
- ▶ Apto para niños de 6 a 26 meses
- ▶ Doble bloqueo para mayor seguridad. Difícil de abrir por los niños.

- ▶ Up to 140 cm. wide
- ▶ For stairs, doors, indoor and outdoor.
- ▶ Auto locking mechanism
- ▶ Easy to use while holding your baby
- ▶ One handed operation.
- ▶ Retractable design
- ▶ Sturdy mesh gate
- ▶ Suitable for children from 6 to 26 months
- ▶ Double lock for added security. Difficult to open by children.

04 SEGURIDAD SAFETY

CARACTERÍSTICAS | FEATURES

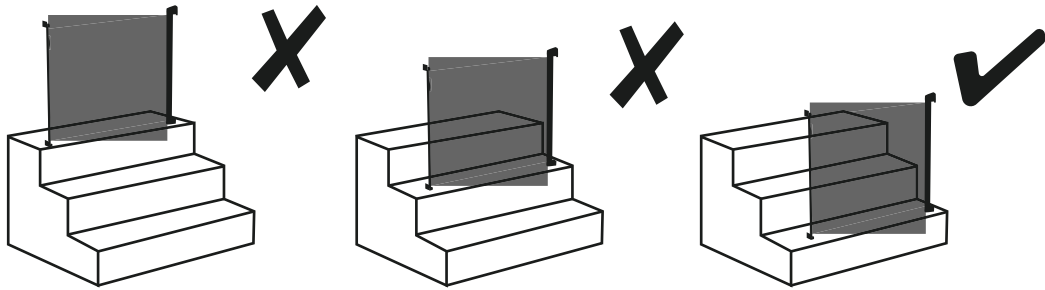
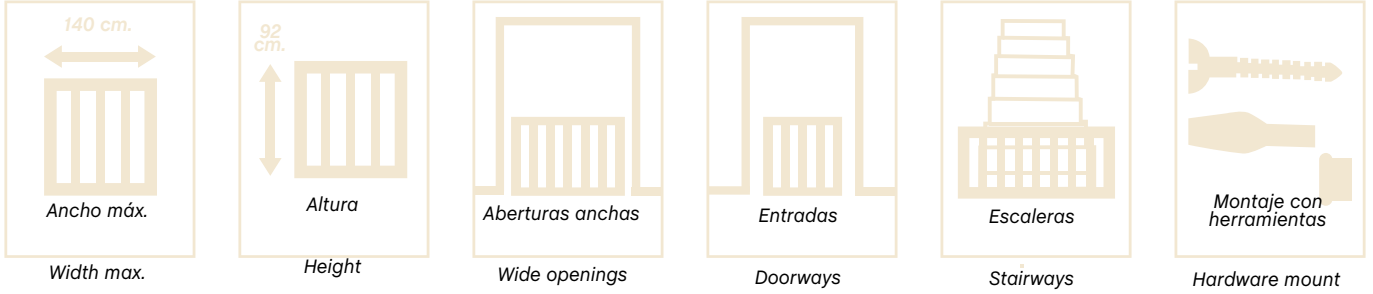

+6m | 92 x 50-140 cm. | 4,800 kg.

COLORES | COLORS

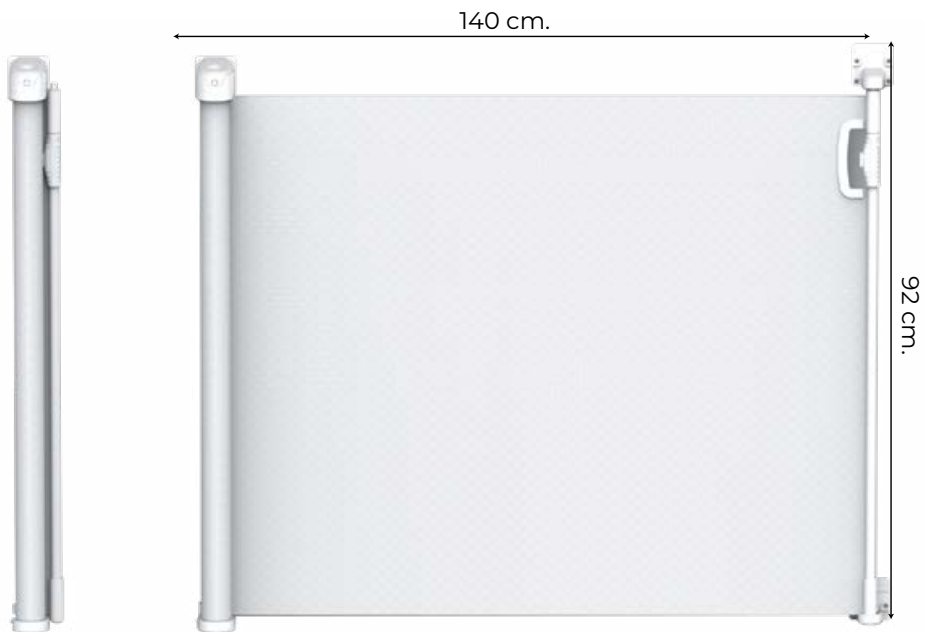

XY011 WHITE



7820 STOPPER II PARA PUERTAS 1 Unid.



7823 CIERRE SEGURIDAD ÁNGULO 1 Unid.



7824 PROTECTOR FLEXIBLE ARMARIOS 1 Unid.



7826 CIERRE MULTIUSOS 1 Unid.



7829 PROTECTOR ESQUINAS CAUCHO 4 Unid.



7831 CIERRE SEGURIDAD

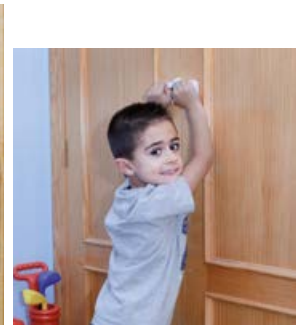

7832 CIERRE SEGURIDAD ARMARIOS 2 Unid.



7834 PROTECTOR DEDOS PUERTAS 1 Unid.



CONFORT
COMFORT



- ▶ Se puede utilizar desde el nacimiento ayudando a conciliar el sueño
- ▶ Ayuda al correcto desarrollo del cráneo del bebé previniendo la plagiocefalia o cabeza plana
- ▶ Diseño ergonómico, tejido de material suave y agradable y relleno de espuma memory foam
- ▶ Con una cavidad central para un mejor ajuste de la cabeza, consiguiendo mayor contacto con la superficie y un mejor apoyo
- ▶ Interior con agujeros para una mayor ventilación

- ▶ It can be used from birth to help you fall asleep
- ▶ Helps the correct development of the baby's skull preventing plagiocephaly or flat head
- ▶ Ergonomic design, soft and pleasant material fabric and memory foam filling.
- ▶ With a central cavity for better adjustment of the head, getting more contact with the surface and better support
- ▶ Interior with holes for more ventilation

05 CONFORT COMFORT

CARACTERÍSTICAS | FEATURES



Espuma memory foam
Memory foam



Cavidad central para un mejor apoyo
Central cavity for better support

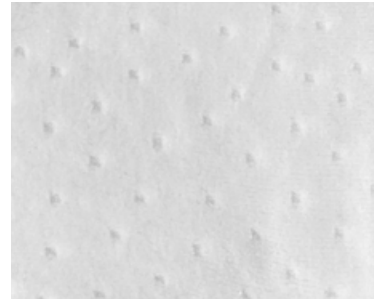

Tejido suave y agradable
Soft and pleasant fabric



+0m | 26 x 22 x 3 cm. | 0'225 kg.

COLORES | COLORS

SOPORTE PARA
EL CUELLO
NECK SUPPORT

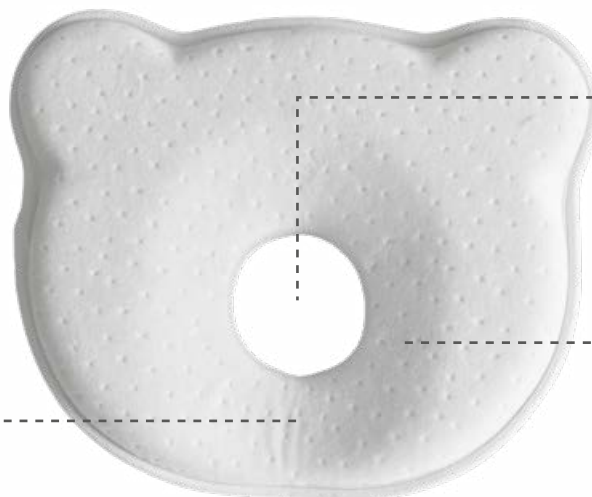

AGUJERO PARA LA
NUCA
NAPE HOLE

ÁREA DE FIJACIÓN
AUXILIAR
AUXILIARY FIXATION
AREA

1320 WHITE



- ▶ Puede ser utilizado tanto para la embarazada como para el bebé
- ▶ Actúa como soporte, aportando un apoyo abdominal firme que ayuda a evitar los dolores de espalda durante el embarazo
- ▶ Plano de inclinación de 15° (inclinación recomendada en pediatría), elevará ligeramente la cabeza del bebé facilitando la respiración y la digestión del bebé durante el sueño, previniéndole además la regurgitación y garantizándole así un mejor sueño
- ▶ Fabricado con materiales suaves y frescos, con interior impermeable
- ▶ Desenfundable para su limpieza

- ▶ The relax pillow can be used for the pregnant mother and the baby
- ▶ Acts as a support, providing a firm abdominal support helps prevent back pain during pregnancy
- ▶ Plane of inclination of 15° (recommended for pediatrics) slightly will raise the baby's head facilitating breathing and digestion baby during sleep, also warning him regurgitation and guaranteeing better sleep
- ▶ It is made of soft and fresh materials, with waterproof material inside
- ▶ Removable lining for cleaning

05 CONFORT COMFORT

CARACTERÍSTICAS | FEATURES



Desenfundable para su limpieza
Removable lining for cleaning

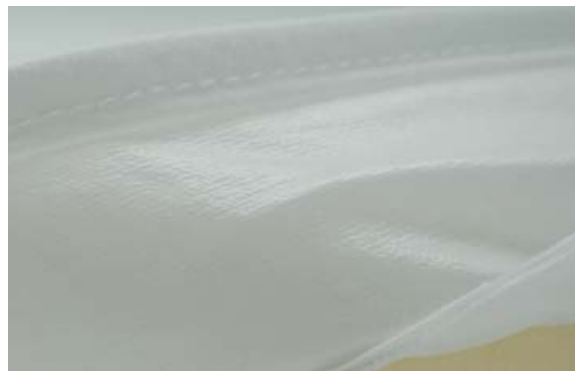

Interior impermeable
Waterproof inside

+0m | 38 x 8 x 30 cm. | 0'132 kg.

COLORES | COLORS



1138 WHITE



- ▶ Muy práctico y cómodo gracias a su acolchado
- ▶ Se adapta fácilmente a diferentes productos para el bebé, como tronas, hamacas, sillas de paseo y sillas de seguridad para el coche
- ▶ Cuando el niño crece, basta con retirar el reductor interior y el cojín cuña
- ▶ Muy acolchado y mullido
- ▶ Fabricado en algodón muy suave
- ▶ Lavable a máquina

- ▶ Very practical and comfortable thanks to its padded reducer
- ▶ Easily adapts to different baby products, such as high chairs, hammocks, strollers and car safety seats
- ▶ Enlarges by removing the inner head support and wedge cushion
- ▶ Soft quilted towelling
- ▶ Made in very soft cotton
- ▶ Machine washable.

05 CONFORT COMFORT

CARACTERÍSTICAS | FEATURES



Reductor interior extraíble
Removable inner head support



Cojín cuña extraíble
Removable wedge cushion



Posición 1
Position 1



Posición 2
Position 2

+0m | 53x28x8 cm. | 0'200 kg.

COLORES | COLORS



1137 WHITE



COLORES | COLORS



8703 GREY

CARACTERÍSTICAS | FEATURES



*Soporte de cabeza ajustable
Head support adjustable*



*Reverso transpirable
Transpirable reverse*

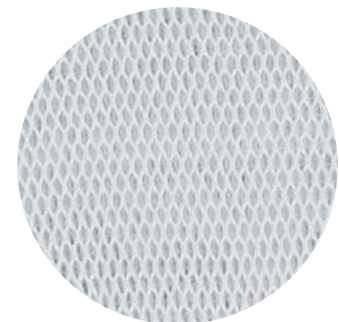

*Tejido 3D transpirable
3D textile transpirable*

- ▶ Colchoneta universal con reverso en tejido 3d transpirable que mantiene a su bebé fresco y seco (crea una cámara de aire para favorecer la transpiración)
- ▶ Circulación constante del aire en la zona de la espalda, las piernas y la cabeza
- ▶ El exceso de calor del cuerpo se elimina y queda reemplazado por aire más fresco del entorno
- ▶ Ayuda a mantener la cabeza del bebé erguida para un mayor confort
- ▶ El soporte de la cabeza se ajusta mediante velcro adaptándose al crecimiento del bebé
- ▶ Se adapta fácilmente a cualquier sillita, portabebés o silla de auto

- ▶ Universal mattress with back in breathable 3d fabric that keeps your baby cool and dry (creates an air chamber to promote perspiration)
- ▶ Constant circulation of air in the back, legs and head
- ▶ Excess heat from the body is eliminated and replaced by fresher ambient air
- ▶ Helps hold baby's head up for extra comfort
- ▶ The head support is adjusted by Velcro to adapt to the growth of the baby
- ▶ Easily fits any stroller, baby carrier or car seat

+0m | 64x42x2'5 cm. | 0'288 kg.

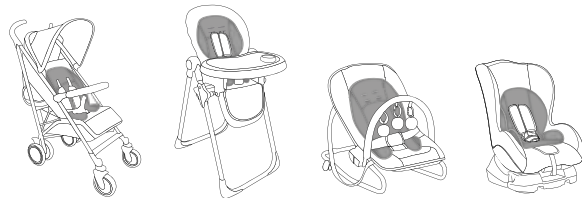

- ▶ Colchoneta reductora muy práctica y confortable gracias a su acolchado
- ▶ Se adapta fácilmente a diferentes productos para el bebé, como tronas, hamacas, sillas de paseo y sillas de coche
- ▶ Máxima comodidad para el niño, ofreciendo una buena transpiración

- ▶ Insert mattress very practical and comfortable thanks to its padded reducer
- ▶ Easily adapts to different baby products, such as high chairs, hammocks, strollers and car seats
- ▶ It offers maximum comfort for the child, providing good transpiration

+0m | 36x54 cm. | 0'182 kg.

COLORES | COLORS



8701 MARINE



8702 GREY

VIAJAR
TRAVEL



- ▶ Plegable, muy ligero y con asa regulable para transportarlo.
- ▶ Convierte cualquier silla de adulto en una trona
- ▶ Correas ajustables para acoplar al respaldo y al asiento de la silla
- ▶ Con práctico bolsillo
- ▶ Cinturón de seguridad regulable según la talla del niño
- ▶ Desenfundable para su limpieza

- ▶ Foldable, very light and with an adjustable handle for transporting it.
- ▶ Turn any adult chair into a high chair
- ▶ Adjustable straps to attach to the back and seat of the chair
- ▶ With practical pocket
- ▶ Adjustable seat belt according to the size of the child
- ▶ Removable cover for cleaning

06 VIAJAR TRAVEL

CARACTERÍSTICAS | FEATURES



Práctico bolsillo
Practical pocket



Plegado compacto
Compact fold



Modo bandolera
Shoulder bag

+6m | 30 x 36 x 26 cm. - 30 x 12 x 26 cm. | 0'720 kg.

COLORES | COLORS



0515 LION



0516 FLY



- ▶ Plegable, ligero y con asa regulable
- ▶ Con prácticos bolsillos
- ▶ Correas ajustables para acoplar al respaldo y al asiento de la silla
- ▶ Asiento con base rígida muy ligera para un apoyo más cómodo
- ▶ Arnés de seguridad ajustable que sujeta al niño firmemente en el asiento
- ▶ La correa de seguridad permite instalar el asiento en la mayoría de sillitas estándar, y se convierte en una correa para colgar en el hombro en forma de bandolera o en la espalda como mochila

- ▶ Foldable, light and with an adjustable
- ▶ Practical pockets
- ▶ Adjustable straps to fit to the chair back and seat to avoid rubbing and scratches
- ▶ Seat with very light rigid base for a more comfortable
- ▶ Adjustable safety harness that holds the child firmly in the seat
- ▶ The safety belt allows the high chair to adapt to the majority of standard high chair. It can also be used as a strap to hang from the shoulder as a bag or backpack

06 VIAJAR TRAVEL

CARACTERÍSTICAS | FEATURES



Arnés de 5 puntos
5 points safety harness



Múltiples compartimentos
Multiple compartments



Plegado compacto
Compact fold

+6m | 35 x 37 x 31 cm - 35 x 16 x 31 cm. | 1,200 kg.

COLORES | COLORS



1275 TIGER



1269 BABY STAR



- ▶ Plegable, ligero y con asa regulable
- ▶ Con prácticos bolsillos
- ▶ Correas ajustables para acoplar al respaldo y al asiento de la silla
- ▶ Asiento con base rígida muy ligera para un apoyo más cómodo
- ▶ Arnés de seguridad ajustable que sujeta al niño firmemente en el asiento
- ▶ La correa de seguridad permite instalar el asiento en la mayoría de sillitas estándar, y se convierte en una correa para colgar en el hombro en forma de bandolera o en la espalda como mochila

- ▶ Foldable, light and with an adjustable
- ▶ Practical pockets
- ▶ Adjustable straps to fit to the chair back and seat to avoid rubbing and scratches
- ▶ Seat with very light rigid base for a more comfortable
- ▶ Adjustable safety harness that holds the child firmly in the seat
- ▶ The safety belt allows the high chair to adapt to the majority of standard high chair. It can also be used as a strap to hang from the shoulder as a bag or backpack

06 VIAJAR TRAVEL

CARACTERÍSTICAS | FEATURES



Arnés de 5 puntos
5 points safety harness



Cambiador incluido
Changing mat included



Múltiples compartimentos
Multiple compartments



Plegado compacto
Compact fold

+6m | 35 x 37 x 31 cm - 35 x 16 x 31 cm. | 1,200 kg.

COLORES | COLORS



1268 LITTLE TOWN



- ▶ Para proteger al bebé y a la familia del viento y el sol
- ▶ Estructura pop-up, ligera y flexible.
- ▶ Ideal para la playa, jardín, terraza,...
- ▶ Muy fácil de instalar o plegar en su bolsa de transporte
- ▶ Con 4 piquetas para fijar a la arena
- ▶ Incluye bolsa de transporte

- ▶ To protect baby and the family from the wind and sun
- ▶ Pop-up structure, light and flexible.
- ▶ Ideal for the beach, garden, terrace,...
- ▶ Very easy to install or fold into its carrying bag
- ▶ With 4 pegs to fix to the sand
- ▶ Includes carrying bag

CARACTERÍSTICAS | FEATURES



Tejido anti-UV para una mayor protección
Anti-UV fabric for greater protection



4 piquetas para fijar a la arena
4 pins to fix to the sand



Sistema POP UP
POP UP system

+10m | 100 x 105 x 90 cm. - 54 x 64 cm. | 0'688 kg.

COLORES | COLORS



0004 CRAB



Bolsa de transporte
Travel bag



- ▶ Tienda y piscina de playa para proteger al bebé del sol y del viento
- ▶ Estructura pop-up, ligera y flexible.
- ▶ Piscina interior (profundidad: 10 cm.)
- ▶ Muy fácil de instalar o plegar en su bolsa de transporte
- ▶ Incluye 4 piquetas para fijar a la arena
- ▶ Bolsa de transporte

- ▶ Tent and beach pool to protect the baby from the sun and the wind
- ▶ Pop-up structure, light and flexible.
- ▶ Indoor pool (depth: 10 cm.)
- ▶ Very easy to install or fold into its carrying bag
- ▶ Includes 4 pins to fix to the sand
- ▶ Travel bag

CARACTERÍSTICAS | FEATURES



Ventana con rejilla para una mejor ventilación
Mesh window for better ventilation

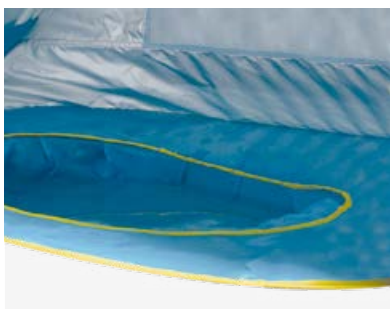

Piscina interior (profundidad: 10 cm.)
Indoor pool (depth: 10 cm.)



4 piquetas para fijar a la arena
4 pins to fix to the sand



Sistema POP UP
POP UP system

+10m | 80 x 115 x 70 cm. - 50 x 59 cm. | 0'790 kg.

COLORES | COLORS



0005 FISH



Bolsa de transporte
Travel bag



- ▶ Protege a tu bebé del viento y del sol mientras se divierte
- ▶ Estructura pop-up, ligera y flexible.
- ▶ Ideal para la playa, jardín, terraza,...
- ▶ Agregue un poco de agua y su bebé podrá chapotear y refrescarse.
- ▶ Muy fácil de instalar o plegar en su bolsa de transporte
- ▶ Bolsa de transporte

- ▶ Tent and beach pool to protect the baby from the sun and the wind
- ▶ Pop-up structure, light and flexible.
- ▶ Ideal for the beach, garden, terrace,...
- ▶ Indoor pool (depth: 10 cm.)
- ▶ Very easy to install or fold into its carrying bag
- ▶ Includes 4 pins to fix to the sand
- ▶ Travel bag

CARACTERÍSTICAS | FEATURES



Con un poco de agua su bebé podrá chapotear y refrescarse
With some water your baby can splash about and cool down



Fácil montaje
Easy assembly



Sistema POP UP
POP UP system

+10m | Ø 80 x 63 cm. - 48 x 57 cm. | 0'616 kg.

COLORES | COLORS



0006 DEEP BLUE



Bolsa de transporte
Travel bag



- ▶ Luz LED de modo dual con control remoto
- ▶ Espejo convexo de gran angular extragrande
- ▶ Ayuda a vigilar al bebé mientras conduce
- ▶ Espejo ajustable de 360° que se acopla fácilmente a la mayoría de los reposacabezas
- ▶ Mando control con clip para ajustar en la visera del coche
- ▶ Fácil instalación
- ▶ Espejo resistente a roturas

- ▶ Dual-mode LED light with remote
- ▶ Extra large wide angle convex mirror
- ▶ Helps keep an eye your baby while driving
- ▶ Fully 360° adjustable mirror easily attaches to most headrests
- ▶ Remote control with clip to fit on the car sun visor
- ▶ Easy installation
- ▶ Shatter-resistant mirror

06 VIAJAR TRAVEL

CARACTERÍSTICAS | FEATURES

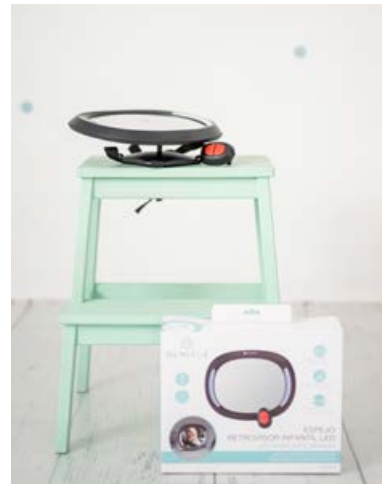

Luz LED
LED light

Mando control
Remote control

+0m | 30 x 25 cm. | 0'616 kg.



COLORES | COLORS



4026 BLACK

10 SEGUNDOS
10-SECONDS

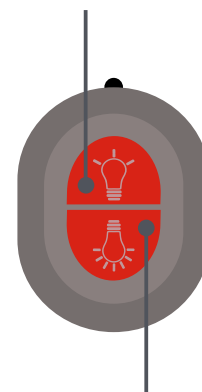

ILUMINACIÓN CONSTANTE
CONSTANT LIGHTING



- ▶ Espejo convexo de gran angular extragrande
- ▶ Ayuda a vigilar al bebé mientras conduce
- ▶ Espejo ajustable de 360° que se acopla fácilmente a la mayoría de los reposacabezas
- ▶ Fácil instalación
- ▶ Espejo resistente a roturas

- ▶ Extra large wide angle convex mirror
- ▶ Helps keep an eye your baby while driving
- ▶ Fully 360° adjustable mirror easily attaches to most headrests
- ▶ Easy installation
- ▶ Shatter-resistant mirror

06 VIAJAR TRAVEL

CARACTERÍSTICAS | FEATURES

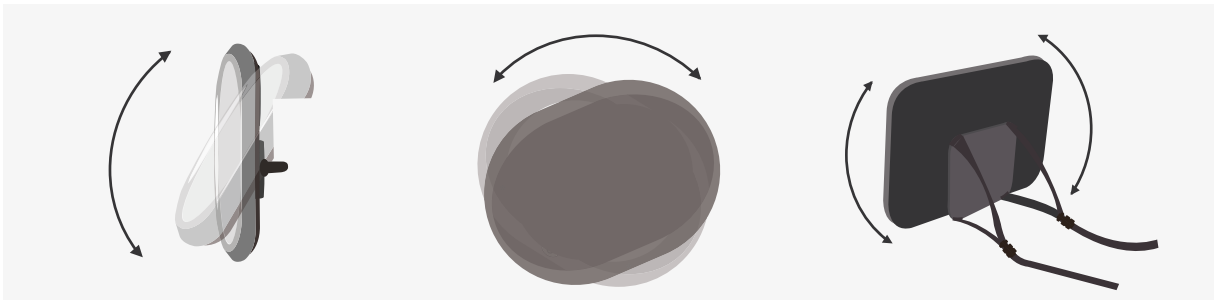

Ajustable 360°
360° adjustable

+0m | 30 x 20 cm. | 0'465 kg.

COLORES | COLORS



4025 BLACK



- ▶ Puedes ver la cara de tu bebé mientras conduces para sentirte más seguro
- ▶ Ideal para las sillas de bebé a contramarcha
- ▶ Puedes ver al bebé y el bebé puede verte a ti
- ▶ Puedes colocar la Tablet de 10" para entretener al bebé durante el viaje
- ▶ Puede ser usado como espejo infantil
- ▶ Espejo de plástico para la seguridad del niño
- ▶ Método sencillo de instalación
- ▶ Cinta ajustable al reposacabezas

- ▶ You can see the face of your baby while driving, to feel safer
- ▶ Ideal rear-facing infant seats
- ▶ You can see baby-baby can see you
- ▶ Can used with the tablet for the entertainment of the baby during the travel
- ▶ It can be used like infant mirror
- ▶ Plastic mirror for the child security
- ▶ Simple attachment method
- ▶ Adjustable belt to the headrest

06 VIAJAR TRAVEL

CARACTERÍSTICAS | FEATURES



Fácil instalación
Easy installation

+0m | 21 x 27 x 2 cm. | 0'233 kg.

COLORES | COLORS



PORTA
TABLET



ESPEJO

4017 BLACK



CARACTERÍSTICAS | FEATURES

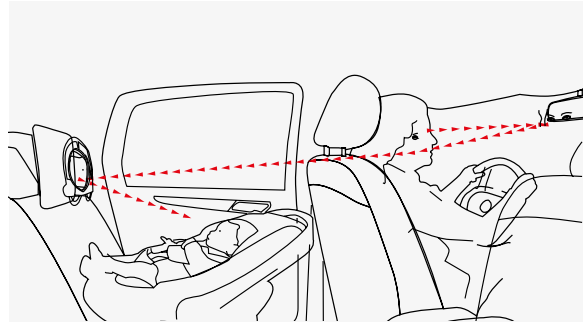

*Puedes ver la cara de tu bebé mientras conduces
You can see the face of your baby while driving*

+0m | 29'5 x 2 x 20'5 cm. | 0'302 kg.

- ▶ Puedes ver la cara de tu bebé mientras conduces para sentirte más seguro
- ▶ Ideal para las sillas de bebé a contramarcha
- ▶ Puedes ver al bebé y el bebé puede verte a ti
- ▶ Espejo convexo extra-grande para un amplio ángulo de visión
- ▶ Puede ser usado como espejo infantil
- ▶ Espejo de material irrompible para mayor seguridad
- ▶ Material antideslizante TM-Grid que ayuda a que el espejo no se mueva
- ▶ Método sencillo de instalación
- ▶ Se adapta a todo tipo de asientos, con reposacabezas y sin reposacabezas

- ▶ You can see the face of your baby while driving, to feel safer
- ▶ Ideal rear-facing infant seats
- ▶ You can see baby-baby can see you
- ▶ Extra-large convex mirror for a wide-angle view of baby
- ▶ It can be used like infant mirror
- ▶ Shatter-proff mirror for added safety
- ▶ Traction-Grid TM fabric helps keep mirror security in place
- ▶ Simple attachment method
- ▶ This rear facing mirror works in all cars no headrest required

COLORES | COLORS



4010 BLACK



- ▶ Podrás ver la cara de tu bebé mientras conduces para sentirte más seguro
- ▶ Ideal para las sillas de bebé orientadas en sentido contrario a la marcha
- ▶ Usted puede ver al bebé y el bebé puede verle a usted
- ▶ Puede ser usado como espejo infantil
- ▶ Espejo de plástico para la seguridad del niño
- ▶ Tranquilidad para los padres y entretenimiento para el bebé
- ▶ Método sencillo de instalación

- ▶ You can see the face of your baby while driving, to feel safer
- ▶ Ideal rear-facing infant seats
- ▶ You can see baby-baby can see you
- ▶ It can be used like infant mirror
- ▶ Plastic mirror for the child security
- ▶ Peace of mind for the parents and entertainment for baby
- ▶ Simple attachment method

06 VIAJAR TRAVEL

CARACTERÍSTICAS | FEATURES



Fácil instalación
Easy installation

+0m | 6 x 21'5 x 31 cm. | 0'200 kg.

COLORES | COLORS



4015 KOALA



4016 CAT

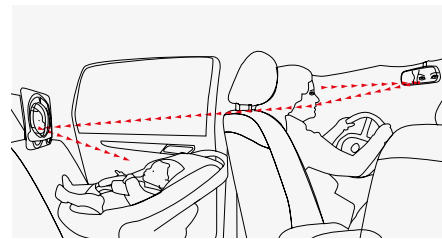

- ▶ Podrás ver la cara de tu bebé mientras conduces para sentirte más seguro
- ▶ Ideal para las sillas de bebé orientadas en sentido contrario a la marcha
- ▶ Usted puede ver al bebé y el bebé puede verle a usted
- ▶ Puede ser usado como espejo infantil
- ▶ Espejo de plástico para la seguridad del niño
- ▶ Tranquilidad para los padres y entretenimiento para el bebé
- ▶ Método sencillo de instalación

- ▶ You can see the face of your baby while driving, to feel safer
- ▶ Ideal rear-facing infant seats
- ▶ You can see baby-baby can see you | It can be used like infant mirror
- ▶ Plastic mirror for the child security
- ▶ Peace of mind for the parents and entertainment for baby
- ▶ Simple attachment method

+0m | 25 x 25 x 4 cm. | 0'243 kg.

COLORES | COLORS



4012 CAR



4014 CRAB



- ▶ Organice y proteja el interior de su coche
- ▶ 3 en 1: protector asiento sillas a contramarcha, protector respaldo de asiento con bolsillo para ipad o tablet y protector asiento sillas infantiles
- ▶ La parte superior e inferior pueden separarse, permitiendo su uso para todas las sillas de coche que el niño vaya a utilizar mientras crezca
- ▶ Con prácticos bolsillos

- ▶ Organize and protect the interior of your car
- ▶ 3 in 1: rear facing chair seat protector, seat back protector with ipad or tablet pocket and child seat protector
- ▶ The upper and lower part can be separated, allowing it to be used in all the car seats that the child will use while growing
- ▶ Practical pockets

06 VIAJAR TRAVEL

CARACTERÍSTICAS | FEATURES



Ventana de PVC para tablet
PVC tablet window



Con prácticos bolsillos
Practical pockets



Material antideslizante
Nonslip material

+0m | 123 x 48'5 cm. | 0'676 kg.

COLORES | COLORS



2741 BLACK



- ▶ Bolsillo de protección que permite el acceso a la pantalla táctil de la tablet y permite una visión clara
- ▶ Provisto de dos bolsillos de malla para guardar biberones y botellas
- ▶ Sistema de anclaje universal que se adapta a la mayoría de asientos
- ▶ Instalación muy sencilla mediante cintas ajustables y hebillas

- ▶ Protective tablet pocket allows touch screen access and wipes clean for clear viewing
- ▶ 2 mesh bottle holds
- ▶ Universal system fits most seat backs
- ▶ Easy to install with adjustable straps and buckles

+0m | 43 x 53 x 0,3 cm. | 0'252 kg.

COLORES | COLORS



4027 BLACK



- ▶ Fácil de instalar y muy práctico durante los viajes
- ▶ Provisto de diferentes departamentos y bolsillos para guardar los juguetes, cuentos y objetos de primera necesidad como biberones, chupetes, etc.

- ▶ Easy to install and very practical for the traveling
- ▶ Provided with different departments and pockets to keep the toys, books and objects of first necessity like baby's bottles, pacifiers, etc.

+0m | 43 x 60 x 1 cm. | 0'258 kg.

COLORES | COLORS



4011 FUNNY CAR



- ▶ Fácil de instalar y muy práctico durante los viajes
- ▶ Provisto de diferentes departamentos y bolsillos para guardar los juguetes, cuentos y objetos de primera necesidad como biberones, chupetes, etc.

- ▶ Easy to install and very practical for the traveling
- ▶ Provided with different departments and pockets to keep the toys, books and objects of first necessity like baby's bottles, pacifiers, etc.

+0m | 48 x 75 x 1 cm. | 0,308 kg.

COLORES | COLORS



4007 TRAVEL BY CAR



- ▶ Protege mejor al bebé de los rayos nocivos y mantiene tu coche fresco durante el verano.
- ▶ Malla de nailon de alta calidad, transpirable y elástica.
- ▶ Se adapta a la mayoría de las ventanas de los automóviles.
- ▶ Se puede abrir y cerrar la ventanilla del coche sin necesidad de quitarla.
- ▶ Evite que el polvo, piedras, insectos, etc. entren al automóvil manteniendo la circulación de aire en el automóvil.
- ▶ Fácil de instalar y de quitar.
- ▶ Permite ver hacia el exterior impidiendo que se vea el interior desde fuera.

- ▶ Protect your baby from harmful rays and keep your car cool during the summer.
- ▶ Made of high quality, breathable and elastic nylon mesh.
- ▶ Fits most car windows.
- ▶ You can open and close the car window without removing it.
- ▶ Prevent dust, stones, insects, etc. get into the car keeping the air circulation in the car.
- ▶ Easy to install and remove. When not in use, you can easily fold them up and store them anywhere.
- ▶ Allows you to see outside while preventing the inside from being seen from the outside.

+0m | 60 x 47 cm. | 0'164 kg.

COLORES | COLORS



1754 BLACK



- ▶ Protege mejor al bebé de los rayos nocivos y mantiene tu coche fresco durante el verano
- ▶ PROTECCIÓN UV. Bloquea más del 95% de los dañinos rayos UV. 50+protección
- ▶ BLOQUEO. Las ventosas mantienen el parasol en su lugar de forma segura ofreciendo mayor adherencia que las ventosas normales
- ▶ MATERIAL ELÁSTICO. Le permite crear un ajuste personalizado para la mayoría de las ventanas

- ▶ Better protect your baby from harmful rays and keep your car cool during the summer
- ▶ UV PROTECTION. Blocks more than 95% of harmful UV rays. 50+ protection
- ▶ BLOCKING. The suction cups hold the sun visor securely in place offering greater adherence than normal suction cups
- ▶ ELASTIC MATERIAL. Allows you to create a custom setting for most windows

06 VIAJAR TRAVEL

CARACTERÍSTICAS | FEATURES



*Ventosas con mayor adherencia
Suction cup with greater adherence*



*Tejido con UV. 50+protección
UV fabric. 50+protection*

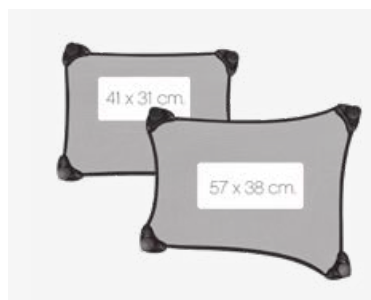

*Tejido elástico
Stretchy fabric*

+0m | 41 x 31 cm. unid. | 0'367 kg. unid.

COLORES | COLORS



0898 BLACK



2
UNIDADES
UNITS

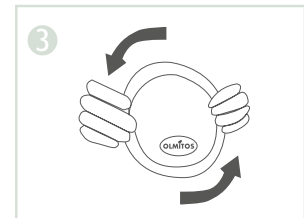
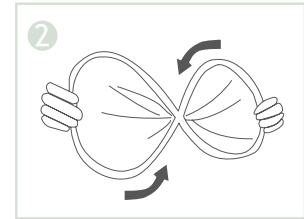
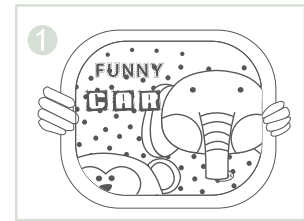

- ▶ Protege al niño de los rayos directos del sol para un viaje más cómodo
- ▶ Se adhiere al cristal mediante dos ventosas
- ▶ Plegado compacto
- ▶ 2 unidades

- ▶ Protects the child from the direct rays of the sun to give a more comfortable journey
- ▶ Fixed to the glass by two suction cups
- ▶ Folds into a compact unit
- ▶ 2 units

+0m | 36 x 44 x 1 cm. | 0'086 kg.

COLORES | COLORS



0869 FUNNY CAR



- ▶ Protege a la mamá y al bebé durante la gestación.
- ▶ Viajes en coche más cómodos y seguros
- ▶ La banda inferior del cinturón queda bajo el abdomen, evitando que se desplace hacia la parte superior del vientre de la embarazada, evitando que el abdomen de la mamá quede presionado
- ▶ Garantiza una acción eficaz del cinturón de seguridad disminuyendo el riesgo de lesiones en caso de sufrir una colisión en el automóvil
- ▶ 2 modos de uso: 3 puntos de fijación con pantalones y 2 puntos de fijación con falda

- ▶ Protect mother and baby during pregnancy.
- ▶ Car trips more comfortable and safe
- ▶ It works by allowing the lower band of the belt to be under the abdomen, preventing it from moving towards the upper part of the pregnant woman's belly, preventing the mother's abdomen from being pressed
- ▶ Guarantees effective action of the seat belt, reducing the risk of injury in the event of a collision in the car
- ▶ 2 modes of use: 3 fixing points with trousers and 2 fixing points with a skirt.

06 VIAJAR TRAVEL

CARACTERÍSTICAS | FEATURES



Acolchado
Padded

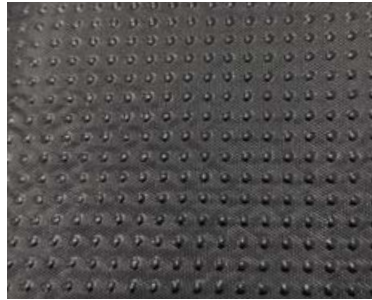

Reverso antideslizante
Non-slip back



Hebilla ajustable
Adjustable buckle



Cierres con clip
Clip closures



Fácil instalación
Easy installation

+0m | 43 x 44 cm. unid. | 0'247 kg.

COLORES | COLORS



1753 BLACK



- ▶ Mantiene las correas del arnés agrupadas y seguras
- ▶ Revestimiento extra de TPR que mantiene las correas firmes y antideslizantes
- ▶ Para todas las correas del arnés de hasta 38 mm de ancho
- ▶ La hebilla de liberación rápida, hace que sea fácil de colocar y de quitar

- ▶ Keeps harness straps close and secure
- ▶ Extra TPR coating keeps the strap firmly and non-slip
- ▶ For all harness webbing up to 38 mm width
- ▶ Quick-release buckle, make it easy to lock and remove.

+0m | 14,5 x 4,2 x 0,8 cm. | 0,032 kg.

COLORES | COLORS



7903 BLACK



- ▶ Guia universal para arnés de seguridad.
 - ▶ Mantiene las correas del arnés agrupadas y seguras
 - ▶ Forma curva para mayor comodidad.
 - ▶ Mantiene las correas del arnés en su lugar.
 - ▶ Material resistente de larga duración.
 - ▶ Se adapta a todas las correas del arnés de hasta 38 mm de ancho.
 - ▶ Fácil de instalar
- ▶ Universal Harness Chest Clip
 - ▶ Keeps harness straps close and secure
 - ▶ Curved shaped for comfort
 - ▶ Keeps the harness straps in place.
 - ▶ Resistant long lasting material
 - ▶ Fits all harness straps up to 38 mm wide
 - ▶ Easy install your harness webbing

+0m | 14'5 x 4'5 x 1 cm. | 0'043 kg.

COLORES | COLORS



7904 BLACK



PASEO
WALK



- ▶ Se puede utilizar de múltiples formas según la edad y las habilidades del niño
- ▶ Se adapta al crecimiento del niño, al tiempo que le facilita a aprender a montar en bicicleta
- ▶ Gracias a sus diferentes etapas, le permitirá utilizar la bicicleta durante más tiempo
- ▶ Cómodo asiento con respaldo regulable
- ▶ Cinturón de seguridad de 5 puntos
- ▶ Manillar regulable con empuñaduras de goma antideslizantes
- ▶ Provisto de un sencillo sistema que permite transformar la bicicleta sin herramientas y ajustarla a la edad del niño
- ▶ Plegado compacto

- ▶ It can be used in multiple ways depending on the child's age and abilities
- ▶ It adapts to the child's growth, while making it easier for him or her to learn to ride a bike
- ▶ Thanks to its different stages, it will allow him to use the bike for longer
- ▶ Comfortable seat with adjustable backrest
- ▶ 5-point safety belt
- ▶ Adjustable handlebar with non-slip rubber grips
- ▶ Equipped with a simple system that allows you to transform the bicycle without tools and adjust it to the age of the child
- ▶ Compact folding

CARACTERÍSTICAS | FEATURES



Manillar regulable
Adjustable handlebar



Pedales desmontables
Removable pedals



Capota plegable y ventilada
Foldable and ventilated canopy

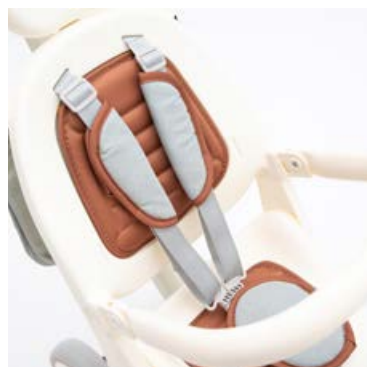

Arnés de seguridad
Safety harness



Bolsillo de almacenaje
Storage pocket



Asiento reversible
Reversible seat



Plegado compacto
Compact folding

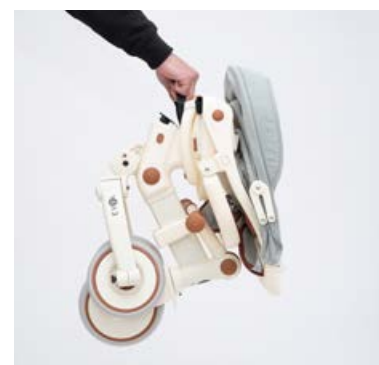

Cinta de transporte
Transport belt



+12m | Hasta 6 años | 96'5 x 49 x 101 cm. | 6'000 kg.

COLORES | COLORS



JY-T11BB BLUE



JY-T11BW WHITE



JY-T11BG GREEN



- ▶ 5 formas diferentes de uso según la edad y las habilidades del niño adaptándose a su crecimiento al tiempo que le facilita a aprender a montar en bicicleta.
- ▶ Gracias a sus diferentes etapas, le permitirá utilizar la bicicleta durante más tiempo.
- ▶ Cómodo asiento regulable en altura con respaldo y cinturón de seguridad desmontable.
- ▶ Manillar regulable con empuñaduras de goma antideslizantes.
- ▶ Con ruedas de goma muy resistentes, la bicicleta se adhiere perfectamente a la superficie, tanto en versión de tres como de dos ruedas.
- ▶ Sencillo sistema que permite transformar la bicicleta sin herramientas y ajustarla a la edad del niño.

- ▶ It can be used in 5 different ways depending on the age and abilities of the child, adapting to their growth while making it easier for them to learn to ride a bicycle.
- ▶ Thanks to its different stages, it will allow you to use the bicycle for a longer time.
- ▶ Comfortable seat height adjustable with backrest and removable seat belt.
- ▶ Adjustable handlebar with non-slip rubber grips.
- ▶ With very resistant rubber wheels, the bike adheres perfectly to the surface, both in three and two-wheel versions.
- ▶ Provided with a simple system that allows you to transform the bike without tools and adjust it to the child's age.

CARACTERÍSTICAS | FEATURES



- ① 1-2 años / years
- ② 1-2 años / years
- ③ 2-3 años / years
- ④ 3-4 años / years
- ⑤ 4-5 años / years



Manillar regulable
Adjustable handlebar



Ruedas de goma muy resistentes
Very resistant rubber wheels



Sillín regulable
Adjustable seat



Pedales desmontables
Removable pedals



Arnés de seguridad
Safety harness

+12m | Hasta 5 años o 25 kg. | 67 x 46 cm. | Altura del asiento: 31 cm - 37 cm. | 5'600 kg.

07 PASEO
WALK

GyRO
BY OLMITOS



COLORES | COLORS



TR007G GREY



TR007B BLUE



TR007M MINT



- ▶ La bicicleta de equilibrio "SPEED-UP" es la mejor forma de aprender a montar en bicicleta, desarrollando el sentido del equilibrio y las habilidades motoras a la vez que el niño se divierte.
- ▶ Plegado compacto con un sólo clic y correa de transporte para poder llevarla a cualquier lugar y guardarla ocupando muy poco espacio.
- ▶ Ligera y robusta, el niño se deslizará con mayor facilidad.
- ▶ Cómodo sillín ergonómico y ajustable en altura.
- ▶ Prevención antivuelco gracias a su manillar con ángulo de giro máx. 110°.
- ▶ Manillar ajustable en altura
- ▶ Ruedas de goma de 47 mm. de alta resistencia al desgaste
- ▶ Sistema de suspensión
- ▶ Mango antideslizante con cubierta de goma suave

- ▶ The "SPEED-UP" balance bike is the best way to learn to ride a bike, developing the sense of balance and motor skills while having fun.
- ▶ Thanks to its compact folding with a single click and its carrying strap, it can be taken anywhere and stored, taking up very little space.
- ▶ Light and robust, the child will slide more easily.
- ▶ Comfortable ergonomic and height adjustable saddle.
- ▶ Rollover prevention thanks to its handlebar with max. 110°.
- ▶ Height adjustable handlebar
- ▶ 47mm rubber wheels. high wear resistance
- ▶ Suspension system
- ▶ Non-slip handle with soft rubber cover

07 PASEO WALK

SPEED-UP

CARACTERÍSTICAS | FEATURES



Fácil De Plegar
Easy To Fold



Estructura del chasis estable
Stable frame structure



Rueda de poliuretano de alta resistencia
High resistant pu wheel



Sistema de suspensión
Suspension system

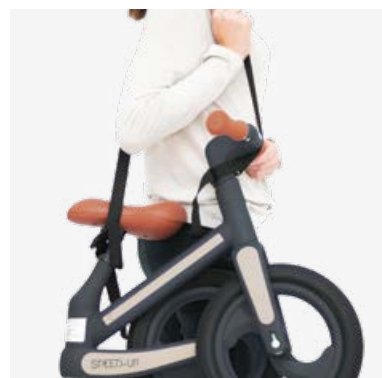

Correa de transporte
Transport strap



+24m | Hasta 5 años | 90 x 56 cm. | 3'500 kg.



COLORES | COLORS



BA001-S STELLAR



BA001-I ICE



- ▶ Ayuda a desarrollar la fuerza, la coordinación, el equilibrio y ganar confianza.
- ▶ Pequeña, ligera y robusta.
- ▶ 2 ruedas delanteras para ofrecer una mayor estabilidad.
- ▶ 2 posiciones de altura.
- ▶ Sillín blando, cómodo y de bordes redondeados.
- ▶ Empuñaduras antideslizantes.
- ▶ Limitación de la rotación de manillar.
- ▶ Plegable.

- ▶ Helps develop strength, coordination, balance and gain confidence.
- ▶ Small, light and robust.
- ▶ 2 front wheels for greater stability.
- ▶ 2 height positions.
- ▶ Soft, comfortable saddle with rounded edges.
- ▶ Non-slip grips.
- ▶ Limitation of handlebar rotation.
- ▶ Foldable.

07 PASEO WALK

CARACTERÍSTICAS | FEATURES



2 posiciones de altura
2 height positions



Manillar 2 etapas
2-stage handlebar

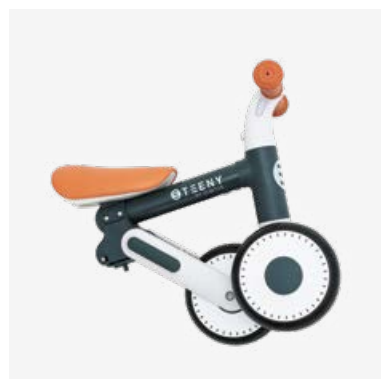

Fácil De Plegar
Easy To Fold

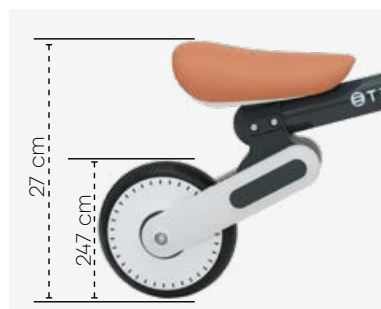

+12m | Hasta 3 años | 49 x 23 x 37 cm. | 1'900 kg.

COLORES | COLORS



WB0608G GRIS



WB0608M MENTA



WB0608V VERDE



Recorrer países, vivir nuevas experiencias, conocer diferentes culturas, lanzarse a la aventura.

Con la nueva silla de paseo IODA todo es posible.

Una silla muy ligera y compacta, útil desde los 0 a los 36 meses y hasta 15 kg, para que los viajes resulten fáciles y divertidos.

Go down countries, live new experiences, meet different cultures, start adventure.

With the IODA pushchair all is possible.

Compact and very light pushchair, useful since 6 to 36 months or 15 kg, for easy and fun travels



- **LA IDEAL COMPAÑERA DE VIAJES.** Con tan solo 5,6 kg de peso y un novedoso sistema de plegado compacto con una sola mano, permite llevarla como equipaje de mano en los aviones, guardarla en la bandeja superior de los trenes o simplemente, llevarla en el coche ocupando muy poco espacio.
- **PENSADA PARA DURAR.** Su estructura de aluminio de alta calidad os permitirá viajar de la forma más sencilla y vivir grandes aventuras alrededor del mundo.
- **CONFORT Y SEGURIDAD.** El respaldo con diferentes posiciones de reclinado y el reposapiés ofrecen un gran confort para el mejor descanso. Su arnés de seguridad de cinco puntos y las almohadillas acolchadas le permitirá libertad de movimiento mientras viaja seguro. Capota con visera y protección solar UV 50.
- **MANIOBRABILIDAD.** Su manillar ergonómico y las ruedas delanteras con giro de 360° facilitan la conducción con una sola mano, permitiendo llevar la otra mano libre para moverte con total autonomía. Incluye sistema de doble freno para mayor seguridad.
- **PENSADA HASTA EL MÍNIMO DETALLE.** Prevista de una cesta de almacenamiento de fácil acceso para tener a mano todo lo que el bebé necesita. Barra protectora extraíble. Con plástico protector de lluvia y mosquitera incluido.
- **THE PERFECT TRAVEL COMPANION.** It only weighs 5,6 kg and it has a new compact folding system with one hand. So, it can be carried as hand luggage in travelling by plane, save in train luggage rack or take it in the car. It will take up very little space!
- **DESIGNED TO LAST.** Your trips will be easy and you will live great adventures around the world thanks to its high quality aluminium structure.
- **COMFORT AND SAFETY.** This pushchair is very easy to carry thanks to its ergonomic handlebar and its four positions back. Its safety harness with five points and its padded pads will allow you freedom of movement while traveling safely. Hood with visor and UV 50 solar protection.
- **MANOEUVRABILITY.** Its ergonomic handles and front wheels with 360° rotation make it easy to drive with one hand, keeping the other hand free to move with total autonomy. It includes double brake system for added security.
- **THINKING TO THE SMALLEST DETAIL.** Provided with an easily accessible storage basket to have everything on hand. Removable protective bar and rain protection plastic included bed net.

07 PASEO WALK

CARACTERÍSTICAS | FEATURES



Fácil de manejar con una sola mano
Easy to handle with one hand



Barra protectora extraíble
Removable protective bar



Arnés de seguridad de cinco puntos
Five point safety harness

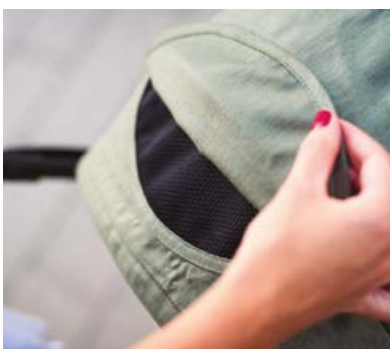

Capota con ventana de ventilación
Hood with ventilation window



Cesta de almacenamiento de fácil acceso
Easy access storage basket



Ruedas con doble freno para mayor seguridad
Wheels with double brake for added safety



Plegado compacto
Compact folding

+0m | Hasta 15 kg. ó 36 meses. | 47 x 103 x 83 cm. - 52 x 29 x 29 cm. | 5'600 kg.

07 PASEO
WALK

COLORES | COLORS



1866 RED



1866 RED



1866 RED



- ▶ Transporte a su hijo cómodamente y sin que se canse en el cochecito
- ▶ Apto para la mayoría de cochecitos de bebé y sillas de paseo
- ▶ Plataforma con superficie antideslizante
- ▶ El niño puede ir sentado o de pie
- ▶ Asiento extraíble
- ▶ Correa ajustable para guardar la plataforma
- ▶ Ruedas blandas para una comodidad óptima

- ▶ Enables you to transport your child comfortably and without fatigue in the pram
- ▶ A universal board for children that will attach to almost any baby carriages and strollers
- ▶ Foot board non-slip surface
- ▶ The child can sit or stand
- ▶ Removable seat
- ▶ Storage adjustable strap
- ▶ Soft wheels for optimum comfort

07 PASEO WALK

CARACTERÍSTICAS | FEATURES



Amplia base antideslizante
Wide non-slip surface base



Asiento con arnés
Seat with harness



Ruedas altamente resistentes
Highly resistant wheels



Correa de transporte
Transport strap

+24m | Hasta 5 años o 25 kg. | 44 x 62/22 x 59 cm. | 4'400 kg. (con asiento)- 3'200 kg. (sin asiento).

COLORES | COLORS



1249 KIDSCOOTER



- ▶ Bandolera regulable
- ▶ Todas las cosas esenciales a su alcance
- ▶ Gran compartimento principal con cremallera
- ▶ Múltiples departamentos interiores, bolsillo exterior con cremallera y bolsillo lateral con redecilla
- ▶ Simple y fácil instalación
- ▶ Correas ajustables adaptables a cualquier silla de paseo

- ▶ Adjustable shoulder strap
- ▶ Your essentials at your fingertips
- ▶ Large main compartment with zipper
- ▶ Multiple interior departments, exterior pocket with zipper and side pocket with mesh
- ▶ Simple and easy installation
- ▶ Adjustable straps fit every strollers
- ▶ Can be removed quickly thanks to the velcro closure

07 PASEO WALK

CARACTERÍSTICAS | FEATURES



Bolsillos laterales
Side pockets



Localizador llavero
Key ring



Bolsillo frontal con cremallera
Front zip pocket



Sistema de fijación al cochecito
System for fixing to the stroller



Asa para colgar
Hanging handle

+0m | 36 x 30 x 10 cm. | 0'369 kg.

07 PASEO WALK

COLORES | COLORS



1206 TIPI BLUE



1207 TIPI PINK



1210 TIPI GREY



1208 CACTUS GREEN



1209 CACTUS MUSTARD



- ▶ Soporte de biberones para carritos de bebé
- ▶ Ideal para mantener los biberones a temperatura adecuada y la comida del bebé durante el viaje
- ▶ Asa para colgar

- ▶ Support bottles for pushchairs
- ▶ Ideal for keeping bottles at a suitable temperature and baby food while traveling
- ▶ Adjustable strap to hold

+0m | 12 x 9 x 24'5 cm. | 0'056 kg.

COLORES | COLORS



1904 GREY



1905 PINK



- ▶ Diseñada para transportar y conservar la comida del bebé caliente o fría durante horas
- ▶ Gran compartimento principal aislado con un bolsillo integrado
- ▶ Compartimento separado, termoaislante, en la base con gomas elásticas para fijar los acumuladores de frío, cubiertos

- ▶ Designed to carry and keep the food hot or cold for hours baby
- ▶ Large main compartment insulated with an integrated pocket
- ▶ Separate, heat-insulating compartment at the base with elastic bands to fix the cold accumulators, covered

07 PASEO WALK

CARACTERÍSTICAS | FEATURES



Compartimento inferior con gomas
Lower compartment rubber bands



Sistema de fijación al cochecito
System for fixing to the stroller

+0m | 23 x 21 x 17 cm. | 0'390 kg.

COLORES | COLORS



1174 GREY



1175 PINK



- ▶ Cómodo, práctico y funcional estuche 2 en 1
- ▶ Estuche 2 en 1 para guardar los pañales y las toallitas húmedas de su bebé.
- ▶ El sello de silicona retiene la humedad para que las toallitas se mantengan frescas.
- ▶ El dispensador interior ayuda a que las toallitas salgan fácilmente.
- ▶ Cómoda correa ideal para transportar.
- ▶ El dispensador de toallitas y la bolsa de pañales se separan fácilmente con velcro para su comodidad.

- ▶ Comfortable, practical and functional 2-in-1 case
- ▶ 2 In 1 Case to store your baby's diapers and wipes.
- ▶ Silicone Seal locks in moisture so wipes stay fresh.
- ▶ Inner spring helps wipes pop up easily.
- ▶ Convenient strap is great for on the go.
- ▶ Wipes dispenser and diaper pouch easily separate with velcro for your convenience.

07 PASEO WALK

CARACTERÍSTICAS | FEATURES



Divisible gracias a los velcros
Divisible thanks to velcro



Práctica asa para su transporte
Practical handle for transport



Bolsillo interior
Inside pocket

+0m | 23 x 13 x 8 cm. | 0'282 kg.

COLORES | COLORS



0896 GREY



- ▶ Diseñado para adaptarse al tubo del chasis del cochecito, carro, cuna, etc. para colgar cosas
- ▶ Correa ajustable con velcro ideal para colgar en cualquier lugar
- ▶ Fácil de instalar
- ▶ Se puede usar tantas veces como se quiera

- ▶ It's designed to connect to the tube and beam in stroller, car, cradle and so on for hanging things
- ▶ With adjustable Velcro strap is great for hanging anywhere
- ▶ Easy on and off installation
- ▶ Repeatable access

+0m | 0'5 x 3'5 x 18 cm. | 0'018 kg. unid.

COLORES | COLORS



0013 BLACK

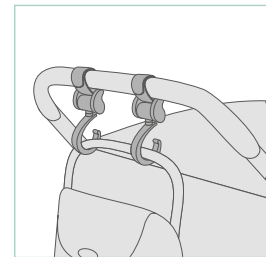
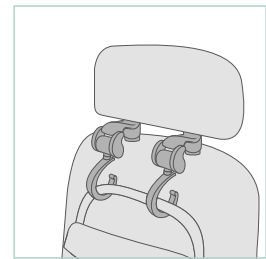
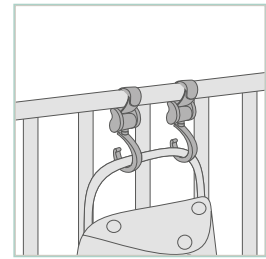

- ▶ Diseñado para adaptarse al tubo del chasis del cochecito, cuna, etc. para colgar diferentes objetos
- ▶ Totalmente giratorio
- ▶ Correa ajustable con velcro, ideal para colgar en cualquier lugar
- ▶ Fácil de instalar

- ▶ It's designed to connect to the tube and beam in stroller, car, cradle and so on for hanging things
- ▶ Is fully rotatable
- ▶ Adjustable velcro strap is great for hanging anywhere
- ▶ Easy on and off installation

+0m | Hasta / up to 5 kg. | 5 x 14 x 2'5 cm. | 0'056 kg. unid.

COLORES | COLORS



1205 BLACK

BAÑO
BATH



+12m | 27 x 15 x 5 cm. | 0,200 kg.

BPA
FREE

- ▶ El niño se divertirá pescando estos 4 muñequitos con la ayuda de esta red
- ▶ ¡3 muñequitos se pueden llenar con agua para salpicar al bebé!
- ▶ Gire la cuerda y la tortuga nadará
- ▶ Desarrolla las habilidades motoras y mejora la coordinación ojo-mano
- ▶ 100% Seguro. No tóxico

- ▶ Having fun fishing for 4 toy characters with the help of a net
- ▶ 3 toy characters can be filled with water to splash Baby!
- ▶ Rotate the chain and the turtle will swim
- ▶ Develops complex motor skills and improves eye-hand coordination
- ▶ 100% Safe. Non-Toxic

COLORES | COLORS



TL856-1 SHARK



TL856-2 JIRAFTE



- ▶ Diversión en el baño
- ▶ Gracias a sus alegres colores y formas redondeadas, el bebé desarrollará sus habilidades cognitivas a la vez que se divierte
- ▶ Producto plástico libre de BPA
- ▶ 100% Seguro. No tóxico

- ▶ Fun moments in the bath
- ▶ Thanks to bright colors and rounded shapes, the baby will develop his cognitive skills while having fun
- ▶ BPA-free plastic product
- ▶ 100% Safe. Non-Toxic



08 BAÑO BATH

CARACTERÍSTICAS | FEATURES



+6m | 15,5 x 12 x 12 cm. | 0'200 kg.

BPA
FREE

COLORES | COLORS



TL811-1 MARINE 6 PZAS



TL821-1 SEA 9 PZAS



TL833-1 OCEAN 6 PZAS



TL832-1 BOATS 6 PZAS



- ▶ Diversión en el baño
- ▶ Gracias a sus alegres colores y formas redondeadas, el bebé desarrollará sus habilidades cognitivas a la vez que se divierte
- ▶ Producto plástico libre de BPA
- ▶ 100% Seguro. No tóxico

- ▶ Fun moments in the bath
- ▶ Thanks to bright colors and rounded shapes, the baby will develop his cognitive skills while having fun
- ▶ BPA-free plastic product
- ▶ 100% Safe. Non-Toxic



08 BAÑO BATH

CARACTERÍSTICAS | FEATURES



+6m | 16 x 16 x 6 cm. | 0'150 kg.

BPA
FREE

COLORES | COLORS



TL825-2 BEACH



TL828-2 ANIMALS

TL817-2 DUCKS



- ▶ Diversión en el baño
- ▶ Gracias a sus alegres colores y formas redondeadas, el bebé desarrollará sus habilidades cognitivas a la vez que se divierte
- ▶ Producto plástico libre de BPA
- ▶ 100% Seguro. No tóxico

- ▶ Fun moments in the bath
- ▶ Thanks to bright colors and rounded shapes, the baby will develop his cognitive skills while having fun
- ▶ BPA-free plastic product
- ▶ 100% Safe. Non-Toxic



08 BAÑO BATH

CARACTERÍSTICAS | FEATURES



+6m | 37 x 6 x 12 cm. | 0'200 kg.

BPA
FREE

COLORES | COLORS



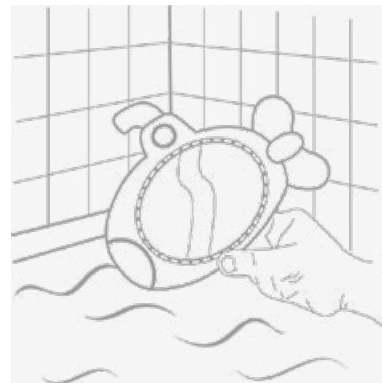

- ▶ El niño se divertirá al ver reflejado su rostro en este espejo infantil.
- ▶ Estimula los sentidos del niño mediante la vista y el tacto.
- ▶ Mojando la parte posterior del espejo se pegará en la baldosa.
- ▶ Producto plástico libre de BPA.

- ▶ Baby enjoy watching his/her face in the baby safe mirror.
- ▶ It stimulates baby's senses and introduces him/her to an exciting world of sight and touch.
- ▶ Wet water on the back of mirror and stick them to the tile.
- ▶ BPA-free plastic product.

+18m | 22 x 18 x 1 cm. | 0'150 kg.

BPA
FREE

COLORES | COLORS



1915 SUBMARINE

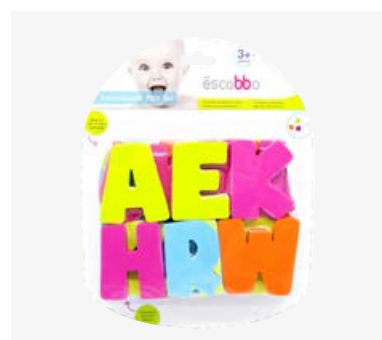
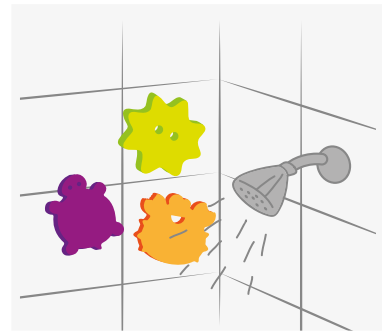

- ▶ ¡Ponga las letras en el agua y estas se adhieren a las baldosas del baño, como por arte de magia!
- ▶ Para la diversión y el aprendizaje al mismo tiempo
- ▶ Flotan en el agua
- ▶ Libre de BPA, libre de F hatalatos

- ▶ Put the letters in the water, and they will stick to the bath tile, like by magic!
- ▶ For fun and learning at the same time
- ▶ Float on water
- ▶ BPA free, Phthalatos free

+36m | 25 x 5,5 x 17 cm. | 0'104 kg.



COLORES | COLORS



EZ1401061 ALPHABETS



EZ3420 MARINE



EZ1401062 NUMBERS



- ▶ Momentos de diversión en el baño
- ▶ Gracias a sus alegres colores y formas redondeadas, el bebé desarrollará sus habilidades cognitivas a la vez que se divierte
- ▶ 100% Seguro. No tóxico
- ▶ Producto plástico libre de BPA

- ▶ Moments of fun in the bathroom
- ▶ Thanks to bright colors and rounded shapes, the baby will develop his cognitive skills while having fun
- ▶ 100% Safe. Non-Toxic
- ▶ BPA-free plastic product

CARACTERÍSTICAS | FEATURES



+4m | 22 x 18 x 17 cm. | 0'360 kg.



COLORES | COLORS



1890 BOTE 16 PATOS
16x23 cm.



1887 PATO COLORES



- ▶ Gran tamaño
- ▶ Momentos de diversión en el baño
- ▶ Gracias a sus alegres colores y formas redondeadas, el bebé desarrollará sus habilidades cognitivas a la vez que se divierte
- ▶ 100% Seguro. No tóxico
- ▶ Producto plástico libre de BPA

- ▶ Big size
- ▶ Moments of fun in the bathroom
- ▶ Thanks to bright colors and rounded shapes, the baby will develop his cognitive skills while having fun
- ▶ 100% Safe. Non-Toxic
- ▶ BPA-free plastic product

+4m | 22 x 18 x 17 cm. | 0'360 kg.



0003 PATO FUNNY



1001 NATURAL

+0m | 13 x 7 x 8 cm. | 0'010 kg.

- ▶ Esponja natural marina muy suave
- ▶ Ideal para los primeros baños del bebé
- ▶ Al ser un producto natural, esta esponja limpia suave y delicadamente la piel del niño proporcionándole un placentero masaje



- ▶ Very gentle natural sea sponge
- ▶ Ideal for baby's first bath
- ▶ Being a natural product, this sponge softly and delicately cleans the child's skin providing a pleasin massage

ESPONJA HIDRÓFILA
SPONGE HYDROPHILIC



1007 HIDRÓFILA

+0m | 8'5 x 9 x 5 cm. | 0'012 kg.

- ▶ Esponja sintética hidrófila
- ▶ La delicada textura que adquiere al contacto con el agua proporciona una suave limpieza mimando la sensible piel del niño
- ▶ Testadas por Wuppertal (Germany) test D.D.5801-E

- ▶ Hydrophilic synthetic sponge
- ▶ A delicate texture is acquired when wet that provides a soft clearing that caresses the child's sensitive skin
- ▶ Tested by Wuppertal (Germany) test D.D.5801-E



- ▶ ¡Haga la hora del baño más segura y divertida!
- ▶ 2 en 1: Cómoda alfombra y protección antideslizante
- ▶ Superficie de material antideslizante y varias ventosas para mayor seguridad
- ▶ Para bañera o plato de ducha
- ▶ Fácil de instalar

- ▶ Will make bath time safer and more fun!
- ▶ 2 in 1: comfortable play-mat & non slip protection
- ▶ Surface of non-slip material and several suction cups for added security
- ▶ For bathtub or shower tray
- ▶ Easy to install

CARACTERÍSTICAS | FEATURES



+0m | 39 x 69 cm. | 0'475 kg.

BPA
FREE



COLORES | COLORS



1311 OCEAN



1310 PANDA



- ▶ Desde el nacimiento hasta los 6 meses (hasta 9 kg.)
- ▶ Comodidad para el bebé gracias a su forma ergonómica y seguridad para los padres.
- ▶ Reclinación ajustable, 3 posiciones de fácil ajuste.
- ▶ Cojín de apoyo para la cabeza / antideslizante.
- ▶ 4 topes antideslizantes en la parte inferior.
- ▶ Con orificios de evacuación del agua.
- ▶ Material suave y resistente.
- ▶ Plegable para su almacenamiento.
- ▶ Gancho para colgar en la pared ocupando mínimo espacio.

- ▶ From birth to 6 months (up to 9 kg.).
- ▶ Comfort for the baby thanks to its ergonomic shape and safety for the parents.
- ▶ Adjustable recline, 3 positions for easy adjustment.
- ▶ Headrest / non-slip cushion.
- ▶ 4 non-slip stops at the bottom.
- ▶ With water evacuation holes.
- ▶ Soft and resistant material.
- ▶ Foldable for storage.
- ▶ Hook to hang on the wall taking up minimal space.

08 BAÑO BATH

CARACTERÍSTICAS | FEATURES



Cojín de apoyo cabeza
Support head cushion



3 posiciones de reclinado
3 recline positions



Orificios de evacuación del agua
Water drainage holes



Desagüe
Drainage



4 topes antideslizantes
4 non-slip stops



Gancho para colgar
Hanging hook

+0m | 59 x 32 x 15-26 cm. | 1'200 kg.

COLORES | COLORS



WY072 GREY



- ▶ Con toalla indeformable que no se deshilacha
- ▶ Confortable y antideslizante
- ▶ La funda puede extraerse fácilmente
- ▶ Se puede lavar a máquina y seca muy rápido

- ▶ With non-deformable towel that does not fray
- ▶ Comfortable and non-slip
- ▶ The cover can be easily removed
- ▶ It can be machine washed and dries very quickly

08 BAÑO BATH

CARACTERÍSTICAS | FEATURES



*Confortable y antideslizante
Comfortable and non-slip*



*Desenfundable
Removable cover*



*Con toalla indeformable
With non-deformable towel*

+0m | 57 x 12'5 x 23 cm. | 0'340 kg.

COLORES | COLORS



1139 DROPS



- ▶ Red de tejido muy suave para un baño sin preocupaciones
- ▶ De fácil utilización, hace más cómodo el baño del bebé
- ▶ Se puede modificar la anchura y longitud de la red para adaptarla a la mayoría de bañeras del mercado

- ▶ Very soft net fabric for bathing without worries
- ▶ Easy to use, makes baby's bathtime more comfortable
- ▶ The width and length of the net can be altered to adapt it to most baths on the market

+0m | 56 x 3 x 55 cm. | 0'095 kg.

COLORES | COLORS



1143 FISH



1144 CRAB



- ▶ Convierte la hora del baño en un momento divertido y relajado
- ▶ Tus manos estarán libres para jugar con el niño
- ▶ Se instala fácilmente mediante 4 ventosas adherentes
- ▶ Movimiento abatible permite colocar al niño fácilmente

- ▶ Turns bath-time into fun-time
- ▶ Your hands are free to play with the baby
- ▶ With 4 non slip suction cups
- ▶ The folding movement help the parents for put the baby easiest

08 BAÑO BATH

CARACTERÍSTICAS | FEATURES



Movimiento abatible
Folding movement



Actividades
Activities



Fijación por ventosas
Suction Cup Fixing

+7m | 32'5 x 30 x 24 cm. | 0'834 kg.



COLORES | COLORS



1179 PANDA BEAR



1988 GREY



- ▶ Convierte la hora del baño en un momento divertido y relajado
- ▶ Tus manos estarán libres para jugar con el niño
- ▶ Se instala fácilmente mediante 3 ventosas adherentes
- ▶ Movimiento abatible permite colocar al niño fácilmente

- ▶ Turns bath-time into fun-time
- ▶ Your hands are free to play with the baby
- ▶ With 3 non slip suction cups
- ▶ The folding movement help the parents for put the baby easiest

08 BAÑO BATH

CARACTERÍSTICAS | FEATURES



*Giratorio
Rotating*



*Movimiento abatible
Folding movement*



*Respaldo abatible
Folding back*



*Fijación por ventosas
Suction cup fixing*



*Actividades
Activities*

+7m | 27 x 28'5 x 22 cm. | 1'240 kg.



COLORES | COLORS



1997 GREY



- ▶ Apoyos de goma antideslizantes en los laterales
- ▶ Departamento para los productos de higiene y cazo para lavar la cabeza
- ▶ Hamaca anatómica extraíble con ventosas antideslizantes
- ▶ Termómetro para calcular la temperatura del agua
- ▶ Práctico tubo de drenaje para eliminar el agua
- ▶ Se puede utilizar sola o con su pie de metal (no incluido)

- ▶ Supports non-slip rubber on the sides
- ▶ Departments for hygienic products and scoopto wash the head
- ▶ Removable anatomical slip hammock with suckers
- ▶ Include a thermometer to calculate the adequate water temperature
- ▶ Practical drain tube to remove the water
- ▶ It can be used alone or with the metallic stand (not included)

08 BAÑO BATH

CARACTERÍSTICAS | FEATURES



Hamaca anatómica
Anatomical hammock



Termómetro
Thermometer



Cacito para lavar la cabeza
Scoop to wash the head



Tubo de drenaje
Drain tube



Hamaca con ventosas antideslizantes
Hammock with non-slip suction cups

+0m | 23 x 52 x 88 cm. | 2'138 kg.

COLORES | COLORS



1898 GREY



1899 MINT



- ▶ La forma más práctica de bañar a tu bebé con la altura ideal
- ▶ Puede usarse en cualquier lugar incluso en el plato de ducha o sobre el bidé ocupando menos espacio en el baño
- ▶ Base muy estable y con un plegado muy compacto
- ▶ Se ajusta a la bañera de Olmitos (no incluida)

- ▶ The most practical way to bath your baby with the ideal height
- ▶ You Can be used anywhere even in the shower or bidet occupying less space in the bathroom
- ▶ Very stable base and compact folding
- ▶ It fits to the Olmitos baby bath (not included)



1008 WHITE

+0m | 97 x 52 x 70 - 112 x 12 x 70 cm. | 3'000 kg.



- ▶ Pensada para llevarla de viaje ocupando muy poco espacio
- ▶ Separador para evitar que el bebé se deslice, seajusta fácilmente mediante un velcro
- ▶ Muy resistente, con 3 válvulas de seguridad
- ▶ Se puede utilizar dentro de una bañera o plato de ducha

- ▶ Designed for travelling
- ▶ With a separator to make sure that the baby cannot slip, is easily adjusted by velcro
- ▶ It takes up very little space
- ▶ Top resistant , with 3 safety valves
- ▶ Easy to use inside the bath or shower base

08 BAÑO BATH

CARACTERÍSTICAS | FEATURES



*Comodidad durante el baño
Comfort during the bath*



*Separador ajustable
Adjustable separator*

+0m | 37 x 50 x 78 cm. | 0'572 kg.

COLORES | COLORS



1302 PALM TREES



- ▶ Piscina con parasol para proteger al niño de los rayos del sol.
- ▶ El espacio perfecto para que tu bebé chapotee, juegue y se divierta.
- ▶ Diferentes usos, piscina con parasol, piscina de bolas o tienda para la playa.
- ▶ Parasol extraíble.
- ▶ PVC muy resistente y no tóxico.
- ▶ Libre de BPA y ftalatos.

- ▶ Pool with canopy to protect the child from the sun's rays.
- ▶ The perfect place for your baby to splash, play and have fun.
- ▶ Different uses, swimming pool with parasol, ball pit or tent for the beach.
- ▶ Removable sunshade.
- ▶ Very resistant and non-toxic PVC.
- ▶ Free of BPA and phthalates.

08 BAÑO BATH

CARACTERÍSTICAS | FEATURES



*Gran espacio de juegos
Great play space*



*Parasol extraíble
Removable sunshade*

+12m | 105 x 105 x 77 cm.

COLORES | COLORS



1199 PALM TREE



- ▶ Diseño divertido y funcional para facilitar el aprendizaje del niño
- ▶ El niño completará las etapas de aprendizaje en su aseo personal
- ▶ Muy versátil, se puede utilizar en 3 modos: orinal, reductor wc y taburete
- ▶ Vaso extraíble para facilitar su limpieza
- ▶ Protección contra salpicaduras
- ▶ Superficie antideslizante
- ▶ Muy fácil de limpiar

- ▶ Fun and functional design to facilitate the child's learning
- ▶ The child completed the stages of learning about personal grooming
- ▶ Very versatile can be used in 3 modes: potty, reducer toilet and stool
- ▶ Removable bowl for easy cleaning
- ▶ Splash protection
- ▶ Non-slip surface
- ▶ Very easy to clean

08 BAÑO BATH

CARACTERÍSTICAS | FEATURES



Reductor wc
Toilette reducer



Taburete
Stool



Vaso extraíble
Pull-on container

+18m | 39 x 32 x 34,5 cm. | 1'800 kg.

COLORES | COLORS



0997 PINK



0996 BLUE



- ▶ Diseño divertido y funcional para facilitar el aprendizaje del bebé
- ▶ Muy fácil de limpiar
- ▶ Se puede utilizar como reductor de wc de forma individual
- ▶ Incluye portarrollos para dispensar el papel higiénico, papel no incluido

- ▶ Fun and functional design to facilitate learning the baby to go to a bathroom only
- ▶ Very easy for cleaning. Removable cup for easy cleaning
- ▶ It can be used as toilet reducer individually
- ▶ It includes paper holder for dispensing toilet paper, paper not included

08 BAÑO BATH

CARACTERÍSTICAS | FEATURES



*Inluye portarrollos
It includes paper holder*



*Reductor wc
Toilette reducer*



*Vaso extraíble
Pull-on container*

+18m | 36'5 x 36'5 x 37 cm. | 1'400 kg.

COLORES | COLORS



1872 MINT



1873 PINK



- ▶ Diseño divertido y funcional para facilitar el aprendizaje del bebé.
- ▶ Vaso extraíble para facilitar su limpieza.
- ▶ Se puede utilizar como reductor de W.C. de forma individual.
- ▶ Incluye portarrollos para dispensar el papel higiénico.

- ▶ Fun and functional design to facilitate learning the baby to go to a bathroom only.
- ▶ Removable cup for easy cleaning.
- ▶ It can be used as toilet reducer individually.
- ▶ It includes paper holder for dispensing toilet paper.

08 BAÑO BATH

CARACTERÍSTICAS | FEATURES



Incluye portarrollos (papel no incluido)
It includes paper holder (paper not included)



Reductor de W.C.
Toilet reducer



Vaso extraíble
Pull-on container

+18m | 36'5 x 36'5 x 37 cm. | 1'400 kg.

COLORES | COLORS



1995 PANDA BEAR



1996 TIGER



1971 BLUE



1871 PINK



- ▶ Diseño divertido y funcional para facilitar el aprendizaje del niño.
- ▶ Similar al WC de un adulto, con tapa y una divertida cisterna.
- ▶ Sonido de descarga de inodoro similar a la de un WC real.
- ▶ Vaso extraíble para facilitar su limpieza.
- ▶ Protección contra salpicaduras.
- ▶ Base con 4 gomas antideslizantes para evitar que se deslice.
- ▶ Muy fácil de limpiar

- ▶ Fun and functional design to facilitate the child's learning.
- ▶ Similar to an adult's WC, with a lid and a fun cistern.
- ▶ Toilet flush sound similar to that of a real toilet.
- ▶ Removable bowl for easy cleaning.
- ▶ Splash protection.
- ▶ Base with 4 non-slip rubbers to prevent it from slipping.
- ▶ Very easy to clean.

08 BAÑO BATH

CARACTERÍSTICAS | FEATURES



Con sonido
With sound



Con respaldo
With backrest



Vaso extraíble
Pull-on container

+18m | 39 x 27 x 32 cm. | 1'000 kg.



COLORES | COLORS



PS1011 GREY



- ▶ Divertido orinal con forma de coche para ayudar al niño a utilizar el WC de forma divertida.
- ▶ 3 en 1: orinal, reductor WC y taburete.
- ▶ Reductor acolchado para una mayor comodidad.
- ▶ Cubeta extraíble para una mejor limpieza.
- ▶ Base antideslizante de 4 puntos para evitar que se deslice.
- ▶ Desmontable y fácil de limpiar.

- ▶ Fun car-shaped potty to help the child use the toilet in a fun way.
- ▶ 3 in 1: urinal, WC reducer and stool.
- ▶ Padded insert for greater comfort.
- ▶ Removable bucket for better cleaning.
- ▶ 4-point non-slip base to prevent slipping.
- ▶ Removable and easy to clean.

08 BAÑO BATH

CARACTERÍSTICAS | FEATURES



Taburete
Stool



Reductor w.c.
W.C reducer



Base antideslizante
Non-slip base



Vaso extraíble
Pull-on container

+12m | 37'5 x 34 x 17,5 cm. - 37'5 x 34 x 42 cm. | 1'400 kg.

COLORES | COLORS



0126 GREY



0125 RED



0127 MINT



- ▶ Práctico y funcional
- ▶ El niño completará las etapas de aprendizaje en su aseo personal
- ▶ Muy versátil se puede utilizar en 3 modos: Orinal, reductor W.C y taburete
- ▶ Vaso extraíble para una mejor limpieza
- ▶ Superficie antideslizante

- ▶ Design practical and functional
- ▶ The child completed the stages of learning about personal grooming
- ▶ Very versatile can be used in 3 modes: potty, reducer toilet and stool
- ▶ Removable bowl for easy cleaning
- ▶ Non-slip surface

08 BAÑO BATH

CARACTERÍSTICAS | FEATURES



Reductor w.c.
W.C reducer



Taburete
Stool



Vaso extraíble
Pull-on container

+18m | 45 x 34 x 35 - 20 x 34 x 35 cm. | 1'092 kg.

COLORES | COLORS



2180 LIGHT BLUE



2181 LIGHT PINK



- ▶ Diseño anatómico y funcional para facilitar el aprendizaje del niño
- ▶ Ligero y compacto, ocupa muy poco espacio
- ▶ Con asas para un mejor transporte
- ▶ Tapa para una mayor higiene
- ▶ Fácil limpieza gracias a su vaso extraíble y al tope antisalpicaduras
- ▶ 4 topes antideslizantes en la parte inferior

- ▶ *Anatomical and functional design to facilitate the child's learning*
- ▶ *Lightweight and compact, it takes up very little space*
- ▶ *With handles for better transport*
- ▶ *Cover for greater hygiene*
- ▶ *Easy cleaning thanks to its removable cup and splash guard*
- ▶ *4 antislip rubber points at the bottom*

08 BAÑO BATH

CARACTERÍSTICAS | FEATURES



Asiento anatómico
Anatomical seat

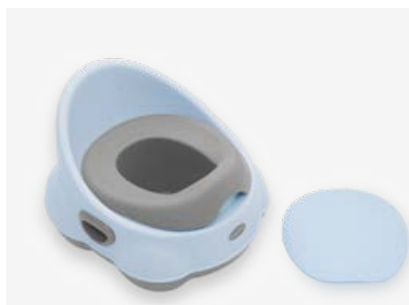

Con tapa para una mayor higiene
With lid for greater hygiene



Fácil de transportar
Pull-on container



Vaso extraíble
Pull-on container



Topes antideslizantes
Non-slip rubber

+18m | 35 x 29 x 27 cm. | 1,160 kg.

BPA
FREE

COLORES | COLORS



0992 BLUE



0993 PINK

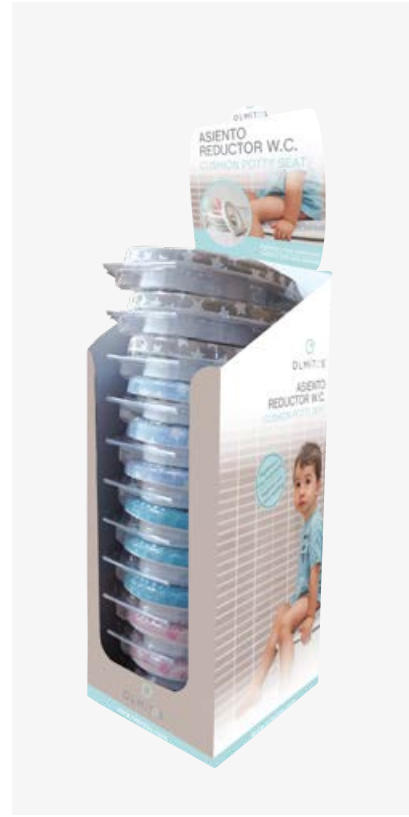

- ▶ Higiénico y con acolchado plastificado
- ▶ Ideal para acostumbrar al niño a utilizar el inodoro como los adultos
- ▶ Con tope para evitar escapes

- ▶ *Hygienic and plasticized padded*
- ▶ *Ideal to get the child accustomed to using the toilet like the adults*
- ▶ *With a barrier to prevent leaks*

08 BAÑO BATH

CARACTERÍSTICAS | FEATURES



*Tope antiescapes
Anti-leak stop*

+18m | 29 x 27 x 7 cm. | 0'277 kg.

COLORES | COLORS



1180 TRIANGLES



- ▶ Las asas ayudan a mantener el equilibrio del niño
- ▶ Higiénico y con acolchado plastificado
- ▶ Ideal para acostumbrar al niño a utilizar el inodoro como los adultos
- ▶ Con tope para evitar escapes
- ▶ Ideal para el aprendizaje del uso del wc
- ▶ Fácil de limpiar

- ▶ *Handles help child balance*
- ▶ *Hygienic and plasticized padded*
- ▶ *Ideal to get the child accustomed to using the toilet like the adults*
- ▶ *With a barrier to prevent leaks*
- ▶ *Ideal for learning to use the W.C*
- ▶ *Easy to clean*

08 BAÑO BATH

CARACTERÍSTICAS | FEATURES



+18m | 32 x 29 x 9 cm. | 0'400 kg.

COLORES | COLORS



1408 OCEAN



1409 DOTS



1410 ANIMALS

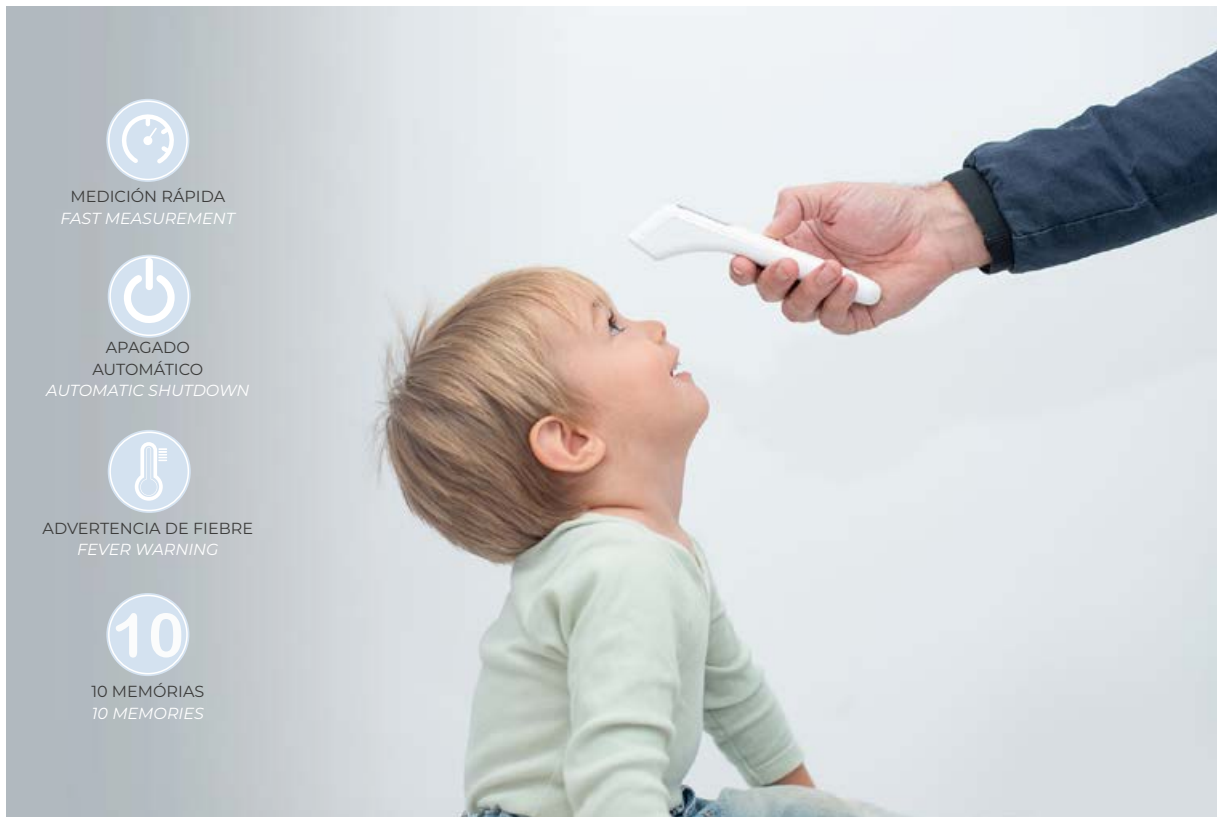

MEDICIÓN RÁPIDA
FAST MEASUREMENT



APAGADO
AUTOMÁTICO
AUTOMATIC SHUTDOWN



ADVERTENCIA DE FIEBRE
FEVER WARNING



10 MEMÓRIAS
10 MEMORIES



- ▶ Fácil de usar, medición con un clic
- ▶ Sin contacto: mida en la frente, sin tocar la piel
- ▶ Aviso de temperatura irregular
- ▶ Almacene 10 conjuntos de datos de medición
- ▶ Unidad de temperatura Fahrenheit y Celsius
- ▶ Aviso acústico cuando la carga de la batería está baja

- ▶ *Easy to use, one-click measurement*
- ▶ *Non contact: measure on forehead, do not touch human skin*
- ▶ *Irregular temperature warning*
- ▶ *Store 10 sets of measurement data*
- ▶ *Temperature unit Fahrenheit and Celsius*
- ▶ *Voice prompt when battery charge is low*

08 BAÑO BATH

CARACTERÍSTICAS | FEATURES



*Sin contacto
No contact*



*Pantalla TFT color verdadero
True color screen TFT*



*Mide la temperatura corporal o
la de los objetos
Measures body temperature or
that of objects*

+0m | 16 x 4 x 3'5 cm. | 0'070 kg.



COLORES | COLORS



1158 WHITE

COMER
EAT



- ▶ Set tres baberos de algodón
- ▶ Muy suaves
- ▶ Ideales para recién nacidos
- ▶ Doble capa, parte trasera de rizo
- ▶ Se pueden quitar rápidamente gracias al cierre de velcro

- ▶ Set of three cotton bibs
- ▶ Very soft
- ▶ Ideal for newborns
- ▶ Double layer, terry cloth back
- ▶ Can be removed quickly thanks to the velcro closure

09 COMER EAT

CARACTERÍSTICAS | FEATURES



Cierre con velcro
Velcro closure

+0m | 27 x 18 cm. unid.

COLORES | COLORS



7061 TIGER



- ▶ Set tres baberos de algodón
- ▶ Muy suaves
- ▶ Ideales para recién nacidos
- ▶ Doble capa, parte trasera de rizo
- ▶ Se pueden quitar rápidamente gracias al cierre de velcro

- ▶ Set of three cotton bibs
- ▶ Very soft
- ▶ Ideal for newborns
- ▶ Double layer, terry cloth back
- ▶ Can be removed quickly thanks to the velcro closure

09 COMER EAT

CARACTERÍSTICAS | FEATURES



Cierre con velcro
Velcro closure

+0m | 27 x 18 cm. unid.

COLORES | COLORS



7063 FOX



- ▶ Set cinco baberos de algodón
- ▶ Muy suaves
- ▶ Impermeables, con parte trasera de material EVA para una mayor protección
- ▶ Se pueden quitar rápidamente gracias al cierre de velcro

- ▶ Set of five cotton bibs
- ▶ Very soft
- ▶ Waterproof, with an EVA material back for greater protection
- ▶ Can be removed quickly thanks to the velcro closure

09 COMER EAT

CARACTERÍSTICAS | FEATURES



Cierre con velcro
Velcro closure

+3m | 31'5 x 22 cm.

COLORES | COLORS



7064 MONSTERS



7065 SCHOOL



- ▶ Set cinco baberos de algodón
- ▶ Muy suaves
- ▶ Impermeables, con parte trasera de material EVA para una mayor protección
- ▶ Se pueden quitar rápidamente gracias al cierre de velcro

- ▶ Set of five cotton bibs
- ▶ Very soft
- ▶ Waterproof, with an EVA material back for greater protection
- ▶ Can be removed quickly thanks to the velcro closure

09 COMER EAT

CARACTERÍSTICAS | FEATURES



Cierre con velcro
Velcro closure

+3m | 33 x 23 cm.

COLORES | COLORS



7066 SPACE



7067 LLAMA



Cierre con velcro
Velcro closure

+3m | 33 x 21 cm.

- ▶ Set cinco baberos de algodón
- ▶ Muy suaves
- ▶ Impermeables, con parte trasera de material EVA para una mayor protección
- ▶ Se pueden quitar rápidamente gracias al cierre de velcro

- ▶ Set of five cotton bibs
- ▶ Very soft
- ▶ Waterproof, with an EVA material back for greater protection
- ▶ Can be removed quickly thanks to the velcro closure

COLORES | COLORS





- ▶ Set diez baberos de algodón
- ▶ Muy suaves
- ▶ Doble capa, parte trasera de rizo
- ▶ Se pueden quitar rápidamente gracias al cierre de velcro

- ▶ Set of ten cotton bibs
- ▶ Very soft
- ▶ Double layer, terry cloth back
- ▶ Can be removed quickly thanks to the velcro closure

09 COMER EAT

CARACTERÍSTICAS | FEATURES



Cierre con velcro
Velcro closure

+3m | 28 x 18 cm.

COLORES | COLORS



7068 DINO



7069 FOREST



- ▶ Babero extragrande
- ▶ Impermeables, con parte trasera de material EVA para una mayor protección
- ▶ Se pueden quitar rápidamente gracias al cierre de velcro

- ▶ Extra large bib
- ▶ Waterproof, with an EVA material back for greater protection
- ▶ Can be removed quickly thanks to the velcro closure

09 COMER EAT

CARACTERÍSTICAS | FEATURES



Cierre con velcro
Velcro closure

+6m | 44'5 x 23 cm.

COLORES | COLORS



7072 TOWN



7073 COUNTRY



- ▶ Pack de 2 baberos con cuello elástico
- ▶ Fácil colocación (como una camiseta)
- ▶ Doble capa, parte trasera de rizo
- ▶ Fabricados en suave algodón

- ▶ Pack of 2 bibs with elastic neck
- ▶ Easy donning (like a T-shirt)
- ▶ Double layer, terry cloth back
- ▶ Made of soft cotton

09 COMER EAT

CARACTERÍSTICAS | FEATURES



Cuello elástico
Elastic neck

+6m | 38 x 23'5 cm.

COLORES | COLORS



7074 ROBOTS



7075 WOODLAND



Bolsillo recogemigas
Crumb pocket



Cierre con velcro
Velcro closure

- ▶ Fabricados de material PEVA totalmente impermeable
- ▶ Con bolsillo recogemigas
- ▶ Se pueden quitar rápidamente gracias al cierre de velcro
- ▶ Fácil limpieza

- ▶ Made of completely waterproof PEVA material
- ▶ With crumb pocket
- ▶ Can be removed quickly thanks to the velcro closure
- ▶ Easy cleaning

+6m | 39 x 35 cm.

COLORES | COLORS



7077 MUFFIN

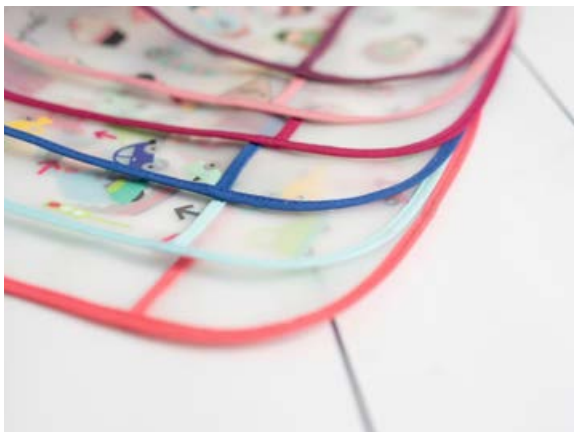

- ▶ Fabricados de material PEVA totalmente impermeable
- ▶ Con bolsillo recogemigas
- ▶ Se pueden quitar rápidamente gracias al cierre de velcro
- ▶ Fácil limpieza

- ▶ Made of completely waterproof PEVA material
- ▶ With crumb pocket
- ▶ Can be removed quickly thanks to the velcro closure
- ▶ Easy cleaning

09 COMER EAT

CARACTERÍSTICAS | FEATURES



Bolsillo recogemigas
Crumb pocket



Cierre con velcro
Velcro closure

+6m | 39 x 35 cm.

COLORES | COLORS



7078 VEHICLES



7079 MATRIOSKA



- ▶ Set de 3 bandanas de algodón suave
- ▶ Mantiene la ropa seca de babitas, ideal para cuando salen los dientes
- ▶ Cierre mediante dos botones a presión para ajustarse individualmente

- ▶ Set of 3 soft cotton bandanas
- ▶ Keeps clothes dry from slime, ideal for when teeth erupt
- ▶ Two snap button closure for individual adjustment

09 COMER EAT



*Bolsillo recogemigas
Crumb pocket*



*Cierre con botones a presión
Velcro closure*

+6m | 26 x 21 cm.

COLORES | COLORS



7088 CLOUDS



7089 WINTER



7090 CIRCLES



- ▶ Vajilla de 10 piezas especialmente diseñada para los niños
- ▶ CONTIENE: Bol, plato llano, plato termo, cuchara silicona, cuchara, tenedor, taza, tapa con boquilla, embudo y ventosa para fijar los platos a la mesa
- ▶ Fabricada de melamina de primera calidad
- ▶ Se puede lavar en lavavajillas. Sólo apta en el compartimento superior del lavaplatos
- ▶ Edad recomendada de 4 a 36 meses
- ▶ Material no tóxico

- ▶ A 10 place set designed especially for children
- ▶ CONTAINS: Bowl, flat plate, thermo plate, silicone spoon, spoon, fork, cup, lid with spout, funnel and suction cup to fix the dishes to the table
- ▶ Made of high quality melamine
- ▶ Can be washed in the dishwasher. Safe for top rack dishwasher
- ▶ Recommended age from 4 months to 36 months
- ▶ Non-toxic material

09 COMER EAT

CARACTERÍSTICAS | FEATURES



+4m | 37 x 45 x 8 cm.

BPA
FREE

COLORES | COLORS



6965 FOREST



- ▶ Botella infantil cómoda y fácil de llevar, para los más pequeños de la casa que se abre y se cierra con facilidad
- ▶ Contiene 1 frasco de tritán de alta calidad alimentaria (500 ml), 1 frasco de acero inoxidable 316 (350 ml), tapa hermética y bolsa de transporte de neopreno
- ▶ Boquilla de aprendizaje de silicona ancha, con un sistema de cierre más higiénico y sin tapones cerrados, que cubre completamente la boquilla cuando no está en uso
- ▶ El tritán, soporta altas temperaturas, no libera productos químicos y es inodoro. Además, tiene una gran dureza y buena resistencia al impacto
- ▶ Sistema de protección ideal para los más pequeños gracias a su fácil apertura mediante botón
- ▶ Asa de transporte para llevarlo cómodamente a todas partes

- ▶ Comfortable and easy-to-carry children's bottle, for the smallest of the house and that opens and closes easily
- ▶ Contains 1 food-grade tritan bottle (500 ml), 1 316 stainless steel bottle (350 ml), airtight lid and neoprene carrying bag
- ▶ Wide silicone learning mouthpiece, with a more hygienic closure system and without closed caps, which completely covers the mouthpiece when not in use
- ▶ Tritan withstands high temperatures, does not release chemical products and is odourless. In addition, it has high hardness and good impact resistance
- ▶ Ideal protection system for the little ones thanks to its easy opening with a button
- ▶ Carrying handle to carry it comfortably everywhere

09 COMER EAT

CARACTERÍSTICAS | FEATURES



Fácil de usar con una sola mano
Easier to use with one hand operation



Pajita de silicona
Silicone straw



Mango suave de silicona
Silicone soft handle



Funda de transporte de neopreno con correa
Neoprene carry bag with strap



Parte inferior antideslizante
Non slip bottom

+4m | Pack: 8'5 x 20 x 29 cm. | Capacidad 350 ml. - 500ml. | Pack: 0'635 kg.

BPA
FREE

COLORES | COLORS



1765 DINO

1766 MERMAID



NO APTO PARA LAVAVAJILLAS
DISHWASHER SAFE

NO APTO PARA
MICROONDAS
NOT SUITABLE FOR DI-
SHWASHER



- ▶ Con este pack, el niño tendrá todo lo necesario para llevar el almuerzo al cole
- ▶ Compuesto por botella de tritán con 2 tapas, (una con pajita y una con bocal) y fiambreira
- ▶ **BOTELLA DE TRITÁN (350ml.)** El tritán, resiste a altas temperaturas, no libera productos químicos y es inodoro. Además, posee gran dureza y buena resistencia al impacto
- ▶ Sistema de cierre ideal para los más pequeños gracias a su fácil apertura mediante un botón
- ▶ **FIAMBREIRA (600ml.)** Fácil de abrir y cerrar, gracias a los 4 prácticos clips en la tapa hermética
- ▶ Anillo de sellado de silicona a prueba de fugas
- ▶ Fiambreira interior de acero inoxidable 304
- ▶ 2 compartimentos con proporción ajustable

- ▶ With this pack, the child will have everything they need to bring lunch to school
- ▶ Composed of a bottle of tritan with 2 lids, (one with a straw and one with a mouth) and a lunch box
- ▶ **BOTTLE OF TRITAN (350ml.)** Tritan resists high temperatures, does not release chemicals and is odorless. In addition, it has great toughness and good resistance to impact
- ▶ Ideal closure system for the little ones thanks to its easy opening by means of a button
- ▶ **LUNCH BOX (600ml.)** Easy to open and close, thanks to the 4 practical clips on the hermetic lid
- ▶ Leak-proof silicone sealing ring
- ▶ Inner 304 stainless steel lunch box
- ▶ 2 compartments with adjustable proportion

09 COMER EAT

CARACTERÍSTICAS | FEATURES



Tapa con pulsador
Push-button lid



2 tapas, con pajita y con bocal
2 lids, with a straw and with a nozzle



Pajita silicona de calidad alimentaria
Food-grade silicone straw



Con correa de nailon ajustable
With adjustable nylon strap



2 compartimentos ajustables
2 compartments adjustable

+4m | Pack: 9 x 24 x 25 cm. | Capacidad 350 ml. - 600ml. | Pack: 0'525 kg.

BPA
FREE

COLORES | COLORS





► **TERMO LIQUIDOS (480ml.)** Indispensable para mantener las bebidas y líquidos fríos o calientes durante horas, en cualquier lugar. Ideal para la preparación de biberones cuando sale de viaje.

► Cómodo cierre de seguridad con seguro que permite verter el líquido con un fácil sistema sin abrir el tapón interior, presionando simplemente el botón

► INTERIOR: Acero inoxidable 316 / EXTERIOR: Acero inoxidable 304.

► **TERMO PAPILLERO (550ml.)** Mantiene caliente o fría la comida del bebé durante horas cuando vamos de viaje o de paseo

► Doble pared de acero inoxidable para mantener la papilla del bebé caliente durante más tiempo

► Aro de silicona para evitar derrames

► INTERIOR: Acero inoxidable 316 / EXTERIOR: Acero inoxidable 304.

► **HIGH GRADE VACUUM FLASK (480ml.)** This vacuum flask is essential to maintain drinks and liquids cold for hot during hours, wherever you are Ideal for the preparation of baby's bottles when you travel

► Push and safety closure with lock, with an easy system, without opening the stopper, just push the button

► INSIDE: 316 stainless steel / OUTSIDE: 304 stainless steel

► **BABY FOOD VACUUM FLASK (550ml.)** Keeps your baby's food warm or cold for hours when you are out or going for a walk

► Double stainless-steel wall to keep baby's papilla warm for longer

► Silicone ring to avoid spills

► INSIDE: 316 stainless steel / OUTSIDE: 304 stainless steel

09 COMER EAT

CARACTERÍSTICAS | FEATURES



Cierre a presión con seguro
Pressure closure with lock



Salida de agua de tritan libre de BPA
BPA free tritan water outlet



Doble pared de acero inoxidable
Double stainless-steel wall

+0m | Pack: 10'5 x 21 x 27 cm. | 480 ml. - 550ml. | Pack: 0'750 kg.

BPA
FREE

COLORES | COLORS



1769 WHITE



1770 BLUE



1771 PINK



- ▶ Mantiene la temperatura de los líquidos, fríos o calientes, durante horas
- ▶ Cómodo cierre de seguridad que permite verter el líquido, con un fácil sistema, sin abrir el tapón interior, presionando simplemente el botón
- ▶ 18/8 acero inoxidable
- ▶ Ideal para viajar
- ▶ Fácil uso

- ▶ Hold temperature for cold & hot liquids during hours
- ▶ Push and pour stopper, with a easy system, without opening the stopper, just push the button
- ▶ 18/8 stainless steel
- ▶ Perfect for travelling
- ▶ Easy use

09 COMER EAT

CARACTERÍSTICAS | FEATURES



+0m | 7 x 25'5 x 7 cm. | Capacidad 500 ml. | 0'315 kg.

BPA
FREE

COLORES | COLORS



0530 TRIANGLES BLUE



0531 TRIANGLES PINK



- ▶ Mantiene la temperatura de los líquidos, fríos o calientes, durante horas
- ▶ Cómodo cierre de seguridad que permite verter el líquido, con un fácil sistema, sin abrir el tapón interior, presionando simplemente el botón
- ▶ 18/8 acero inoxidable
- ▶ Ideal para viajar
- ▶ Fácil uso

- ▶ Hold temperature for cold & hot liquids during hours
- ▶ Push and pour stopper, with a easy system, without opening the stopper, just push the button
- ▶ 18/8 stainless steel
- ▶ Perfect for travelling
- ▶ Easy use

09 COMER EAT

CARACTERÍSTICAS | FEATURES



+0m | 7 x 25'5 x 7 cm. | Capacidad 500 ml. | 0'315 kg.

BPA
FREE

COLORES | COLORS



1745 DOTS BLUE



1746 DOTS PINK



1747 DOTS BEIGE

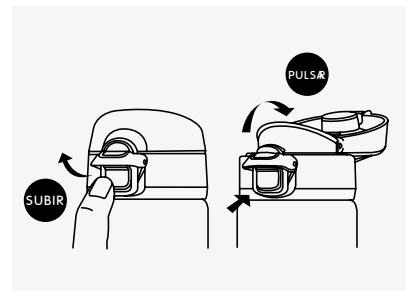

COLORES | COLORS



1762 NAVY BLUE

+0m | 22 x 6'5 x 8 cm. | Capacidad 500 ml. | 0'252 kg.

BPA
FREE



NO APTO PARA
LAVAVAJILLAS
DISHWASHER SAFE



NO APTO PARA
MICROONDAS
NOT SUITABLE FOR DISHWASHER

- ▶ Cómodo cierre de seguridad, con un fácil sistema, sin abrir el tapón interior, presionando simplemente el botón
- ▶ 18/8 acero inoxidable
- ▶ Push and pour stopper, with a easy system, without opening the stopper, just push the button
- ▶ 18/8 stainless steel



- ▶ Diseño moderno, fabricada en acero inoxidable de alta calidad con aislamiento de doble pared
- ▶ La alternativa segura y saludable al plástico
- ▶ Boca ancha permitiendo un llenado más cómodo y rápido
- ▶ No retiene ni transmite los sabores
- ▶ Funda de neopreno desenfundable incluida
- ▶ Acero inoxidable: Exterior: 201 - Interior: 304

- ▶ Modern design, made by high-quality stainless steel with double-wall insulation
- ▶ The healthy safe alternative to plastic.
- ▶ Wide mouth allowing a more comfortable and faster filling
- ▶ Does not retain or transmit flavors
- ▶ Removable neoprene cover included
- ▶ Stainless steel: Exterior: 201 - Interior: 304

09 COMER EAT

CARACTERÍSTICAS | FEATURES



Cierre mediante velcro
Velcro closure

COLORES | COLORS



1734 GREY



1735 PINK



+0m | 7 x 7 x 23 cm. | Capacidad 350 ml. | 0'250 kg.



NO APTO PARA
LAVAVAJILLAS
DISHWASHER SAFE



NO APTO PARA
MICROONDAS
NOT SUITABLE FOR DISHWASHER

COLORES | COLORS

- ▶ Mantiene las bebidas y líquidos fríos o calientes durante horas, en cualquier lugar y ocasión, además es ideal para la preparación de biberones cuando sale de viaje
- ▶ Diseño moderno, fabricado de acero inoxidable de alta calidad con aislamiento de doble pared
- ▶ La alternativa segura y saludable al plástico
- ▶ Sello de goma en la tapa para mantener la botella hermética y a prueba de fugas
- ▶ Ligera e irrompible. Material de alta calidad
- ▶ Maintain drinks and liquids cold or hot during hours, in any place and on any occasion. Ideal for the preparation of baby's bottles when you travel
- ▶ Modern design, made by high-quality stainless steel with double-wall insulation
- ▶ The healthy safe alternative to plastic
- ▶ Rubber seal on the cap to keep the bottle airtight and leak proof
- ▶ Light and unbreakable. High grade material



1732 BEIGE



- ▶ Botella infantil cómoda y fácil de llevar, para los más pequeños de la casa que se abre y se cierra con facilidad
- ▶ Contiene 1 frasco de tritán de alta calidad alimentaria (500 ml), 1 frasco de acero inoxidable 316 (350 ml), tapa hermética y bolsa de transporte de neopreno
- ▶ Boquilla de aprendizaje de silicona ancha, con un sistema de cierre más higiénico y sin tapones cerrados, que cubre completamente la boquilla cuando no está en uso
- ▶ El tritán, soporta altas temperaturas, no libera productos químicos y es inodoro. Además, tiene una gran dureza y buena resistencia al impacto
- ▶ Sistema de protección ideal para los más pequeños gracias a su fácil apertura mediante botón
- ▶ Asa de transporte para llevarlo cómodamente a todas partes

- ▶ Comfortable and easy-to-carry children's bottle, for the smallest of the house and that opens and closes easily
- ▶ Contains 1 food-grade tritan bottle (500 ml), 1 316 stainless steel bottle (350 ml), airtight lid and neoprene carrying bag
- ▶ Wide silicone learning mouthpiece, with a more hygienic closure system and without closed caps, which completely covers the mouthpiece when not in use
- ▶ Tritan withstands high temperatures, does not release chemical products and is odourless. In addition, it has high hardness and good impact resistance
- ▶ Ideal protection system for the little ones thanks to its easy opening with a button
- ▶ Carrying handle to carry it comfortably everywhere

09 COMER EAT



+4m | 7 x 7 x 28 cm. | Capacidad 500 ml. | 0'303 kg.



COLORES | COLORS



1740 BLUE



1741 GREY



1742 BEIGE



1743 PINK



- ▶ Mantiene caliente o fría la comida del bebé durante horas
- ▶ Fabricado en acero inoxidable
- ▶ Doble pared de acero inoxidable para mantener la papilla del bebé caliente durante más tiempo
- ▶ Aro de silicona para evitar derrames

- ▶ Keeps your baby's food warm or cold for hours
- ▶ Made of stainless steel
- ▶ Double stainless steel wall to keep baby's papilla warm for longer
- ▶ Silicone ring to avoid spills

09 COMER EAT

CARACTERÍSTICAS | FEATURES



Asa de transporte
Transport handle

		PERDURABILIDAD TÉRMICA / THERMAL DURABILITY					
		1 Hora/ Hour	2 Horas/ Hours	3 Horas/ Hours	4 Horas/ Hours	5 Horas/ Hours	6 Horas/ Hours
CALIENTE/ HOT	PARTE SUPERIOR/ UPPER PART	65°C	58°C	55°C	52°C	48°C	44°C
	PARTE INFERIOR/ LOWER PART	82°C	75°C	68°C	64°C	58°C	55°C
FRIO/ COLD	PARTE SUPERIOR/ UPPER PART	7°C	9°C	12°C	14°C	15°C	16°C
	PARTE INFERIOR/ LOWER PART	5°C	7°C	9°C	11°C	13°C	14°C

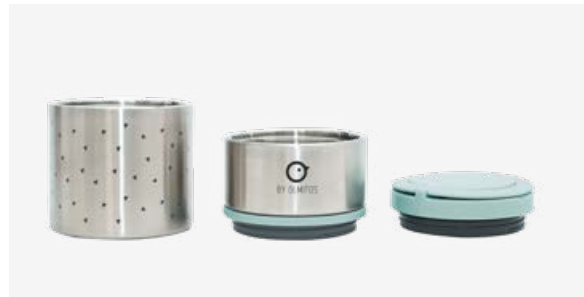

2 prácticos compartimentos
2 practical compartments

+0m | 11'5 x 11'5 x 17'5 cm. | Capacidad 250+570 ml. | 0'450 kg.

BPA
FREE

COLORES | COLORS



0532 TRIANGLES BLUE



0533 TRIANGLES PINK



NO APTO PARA
LAVAVAJILLAS
DISHWASHER SAFE



NO APTO PARA
MICROONDAS
NOT SUITABLE FOR DISHWASHER

0,450 kg. | 11,5x11,5x17,5 cm. | Capacidad 250+570 ml.

BPA
FREE

- ▶ Totalmente automático
- ▶ Ciclo automático de activación y desactivación
- ▶ Extracción automática secuencial: masaje - estimulación - normal
- ▶ Cinco velocidades y potencias personalizables
- ▶ Con una cómoda almohadilla de masaje
- ▶ Funciona con adaptador de corriente (incluido) o baterías

- ▶ Fully automatic
- ▶ Automatic activation and deactivation cycle
- ▶ Automatic sequential: massage - stimulation normal express
- ▶ Custom controlled five speeds and force Levels
- ▶ Natural-touch massage pad for comfort
- ▶ Powered from either a mains adaptor (supplied) or by batteries

COLORES | COLORS



1757 BEIGE



NO APTO PARA
LAVAVAJILLAS
DISHWASHER SAFE

NO APTO PARA
MICROONDAS
NOT SUITABLE FOR
DISHWASHER

- ▶ Muy práctico, resistente y ligero
- ▶ Mantiene caliente o fría la comida durante horas
- ▶ Interior de acero inoxidable
- ▶ Very practical, resistant and light
- ▶ Keeps baby food hot or cold for hours
- ▶ Stainless steel inside

14'5 x 7'5 x 14'5 cm. | Capacidad 460 ml. | 0'296 kg.

BPA
FREE

COLORES | COLORS



1959 PINK



+0m | 21 x 15 x 10 cm. | 0'650 kg.



- ▶ Totalmente automático
- ▶ Ciclo automático de activación y desactivación
- ▶ Extracción automática secuencial: masaje - estimulación - normal
- ▶ Cinco velocidades y potencias personalizables
- ▶ Con una cómoda almohadilla de masaje
- ▶ Funciona con adaptador de corriente (incluido) o baterías

- ▶ Fully automatic
- ▶ Automatic activation and deactivation cycle
- ▶ Automatic sequential: massage - stimulation normal express
- ▶ Custom controlled five speeds and force Levels
- ▶ Natural-touch massage pad for comfort
- ▶ Powered from either a mains adaptor (supplied) or by batteries

COLORES | COLORS



7677 GREY



Plegable
Foldable



12 soportes redondeados
12 rounded supports

+0m | 14 x 25 x 5 cm. | 0'218 kg.



COLORES | COLORS

- ▶ Práctico y funcional
- ▶ Ideal para biberones, chupetes y tetinas
- ▶ Bandeja para el almacenamiento del agua
- ▶ Con 12 soportes redondeados para no rayar los biberones
- ▶ Plegable, ocupa muy poco espacio.
- ▶ Ideal para los viajes
- ▶ Fabricado en PP seguro y resistente.

- ▶ Practical and functional
- ▶ Ideal for bottles, pacifiers and teats
- ▶ Tray for storing water
- ▶ With 12 rounded supports to avoid scratching the bottles
- ▶ Foldable, it takes up very little space
- ▶ Ideal for travel
- ▶ Made of safe and resistant PP

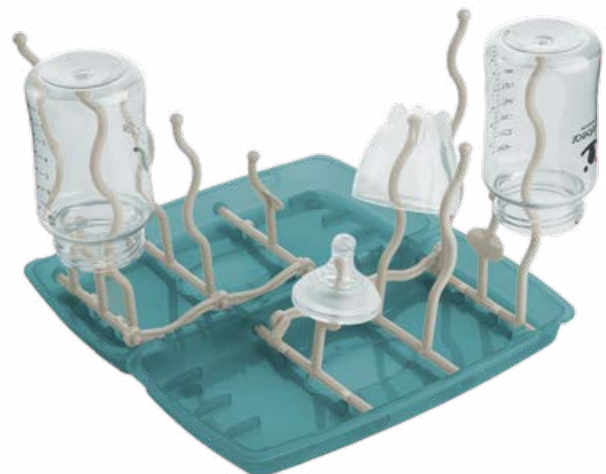

2573 BLUE



www.olmitos.com



OLMITOS,S.A | Pol.Industrial Moinsa, Km. 24 | Calle Boquilla N°3 | Ap.Correos N°2
46640 MOGENTE (VALENCIA) ESPAÑA | Tel.+34 96 226 00 36 | comercial@grupoolmitos.com